



# Air Bursting Munition for 40mm x 53 Automatic Grenade Launchers

Pierre H. Freymond & Allan Buckley  
Oerlikon Contraves Pyrotec AG  
CH-8050 Zurich / Switzerland  
[ocp-marketing@ocag.ch](mailto:ocp-marketing@ocag.ch)

# Air Bursting System Upgrade for All 40 mm Automatic Grenade Launchers



**ONE ABM-SYSTEM for all  
40mm x 53 Weapon  
with minimal modifications !**

# BM Upgrade for AGL Systems Programming Concept

## Vital Features:

- Gun unload safety
- No burst rate limitation
- System works also w/o external Power (Aiming & Impact Function of ABM)

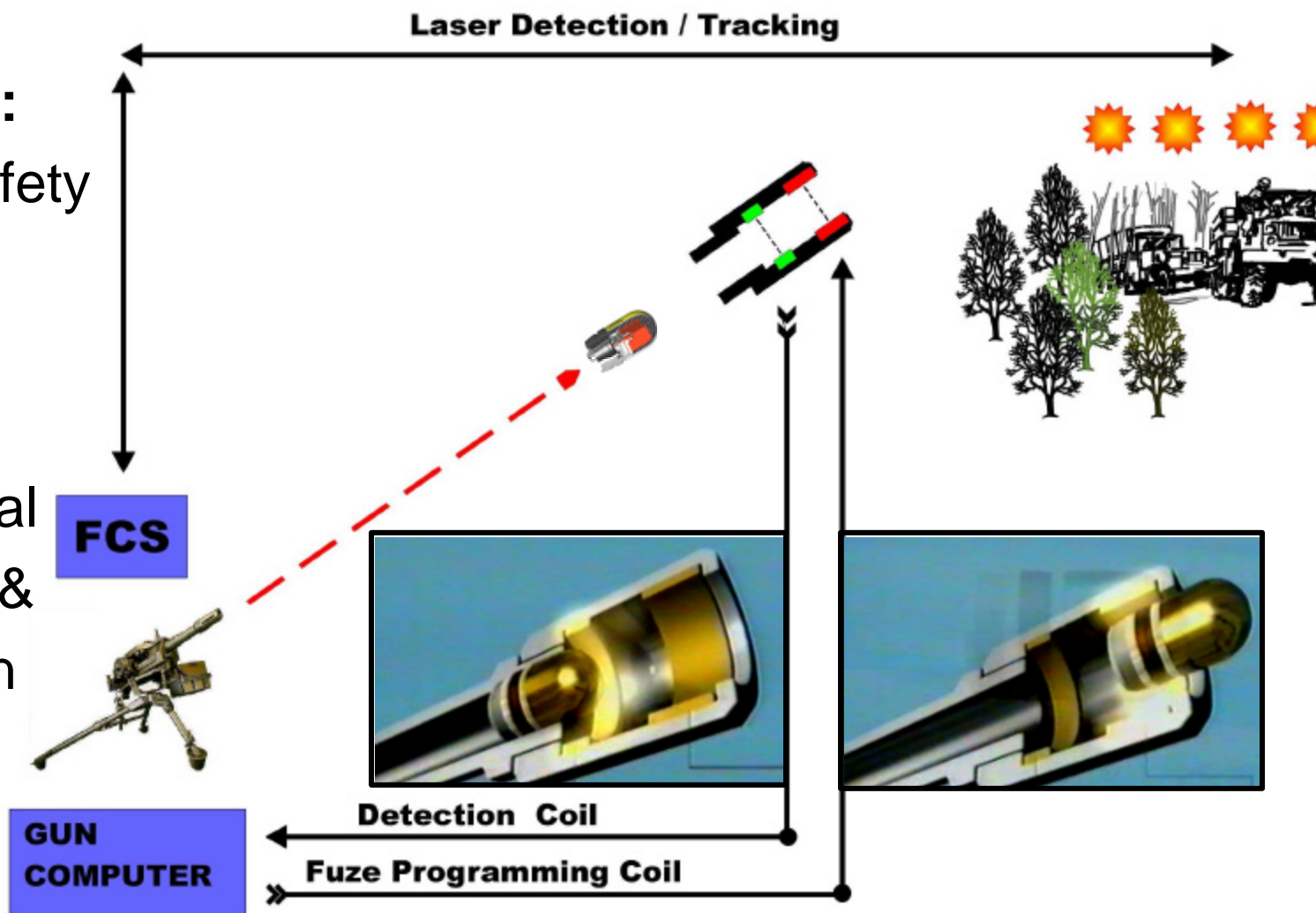

# Weapon and Fire Control System Designs

CONVENTIONAL

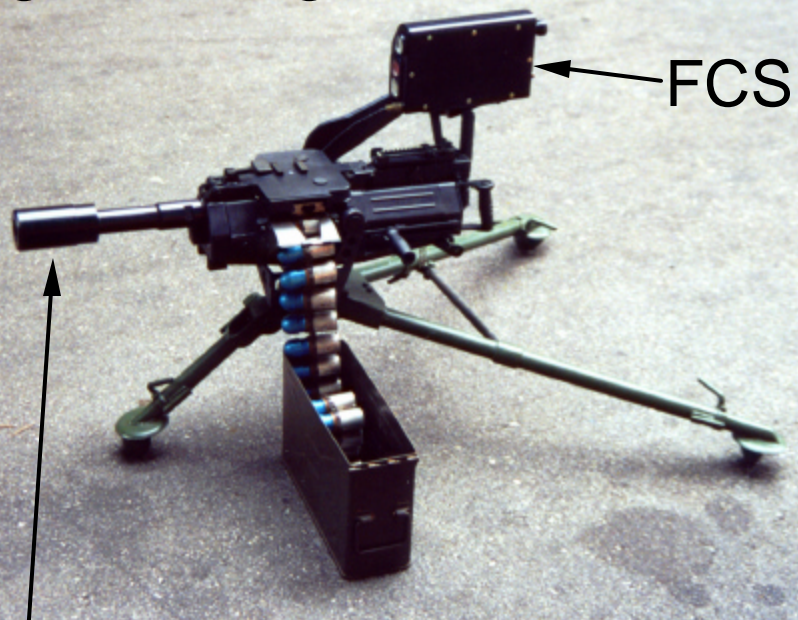

Ammo Programmer

SUPER LIGHT WEIGHT AGL

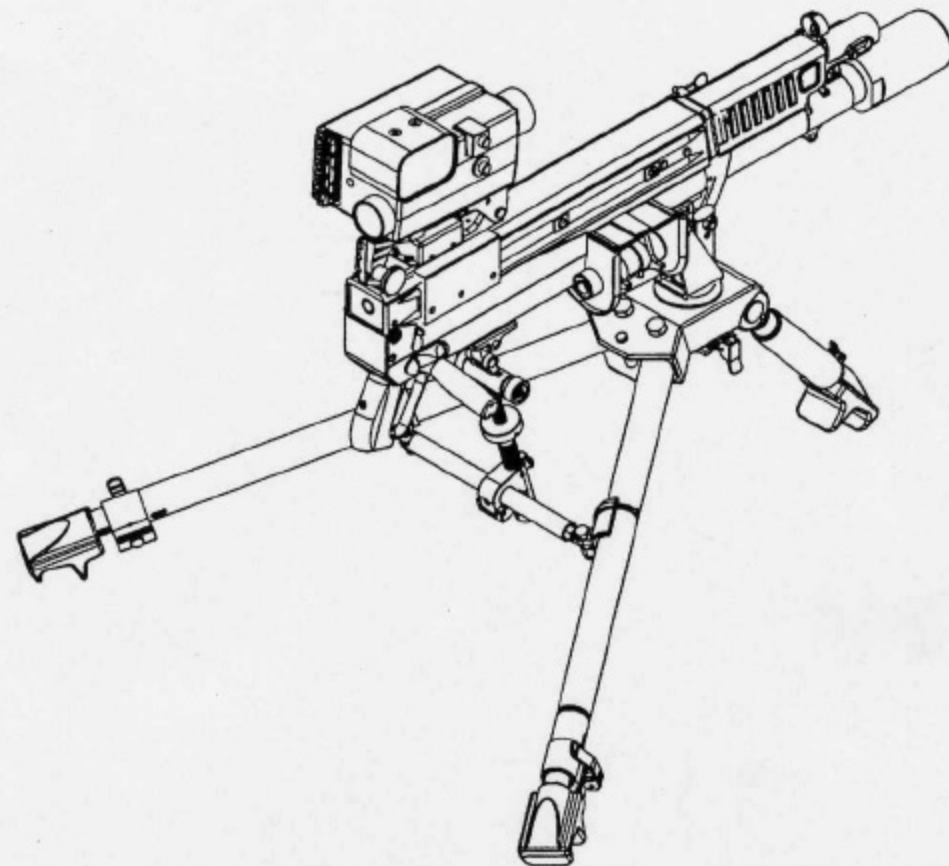

SLWAGL of ST Kinetics

# ABM Family of Oerlikon Contraves

5mm x 228  
head  
ATO Qual.



0mm x 173

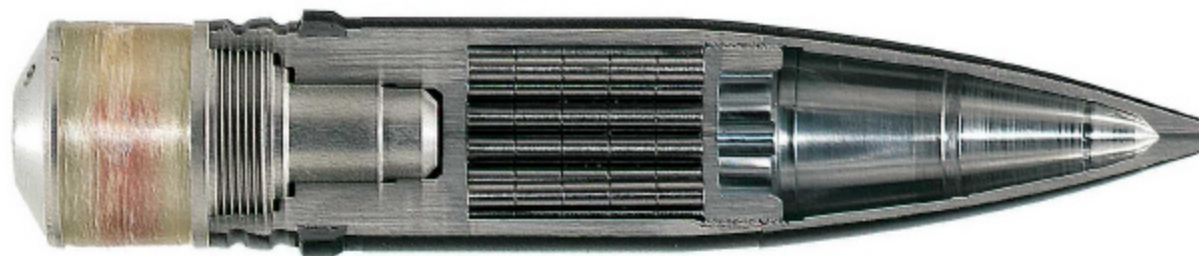

0mm x 53  
selected by  
weden for  
valuation



Other studies on  
following calibers:  
25mm x 137  
27mm x 145  
up to 140 mm

# 35mm Ahead Performances



**Aircraft**



**Missiles**

## 35mm ABM / Ahead



**Soft Targets**



**Tanks**

# One ABM Fuze System (Ahead) - Two Different Warhead Systems

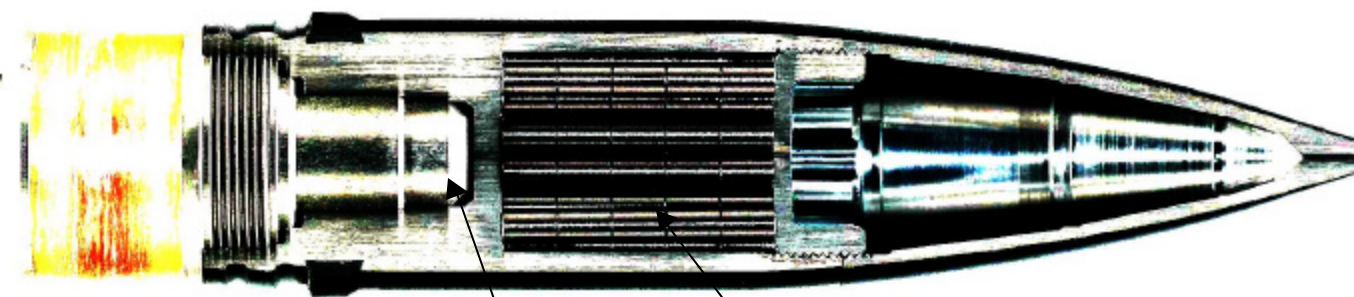

30mm x 173

(35mm x 228)

Ejection  
Charge

**Subprojectile Warhead  
(KETF: Kinetic Energy Time Fuze)**

Programmable  
Base Fuze

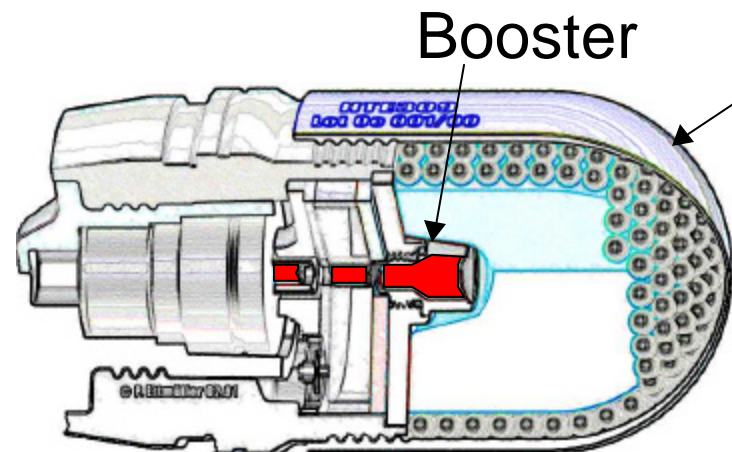

Booster

**Blast Fragmentation Warhead  
(HETF: High Explosive Time Fuze)**

40mm x 53

# AGL Air Bursting Munition: One Fuze for All Types

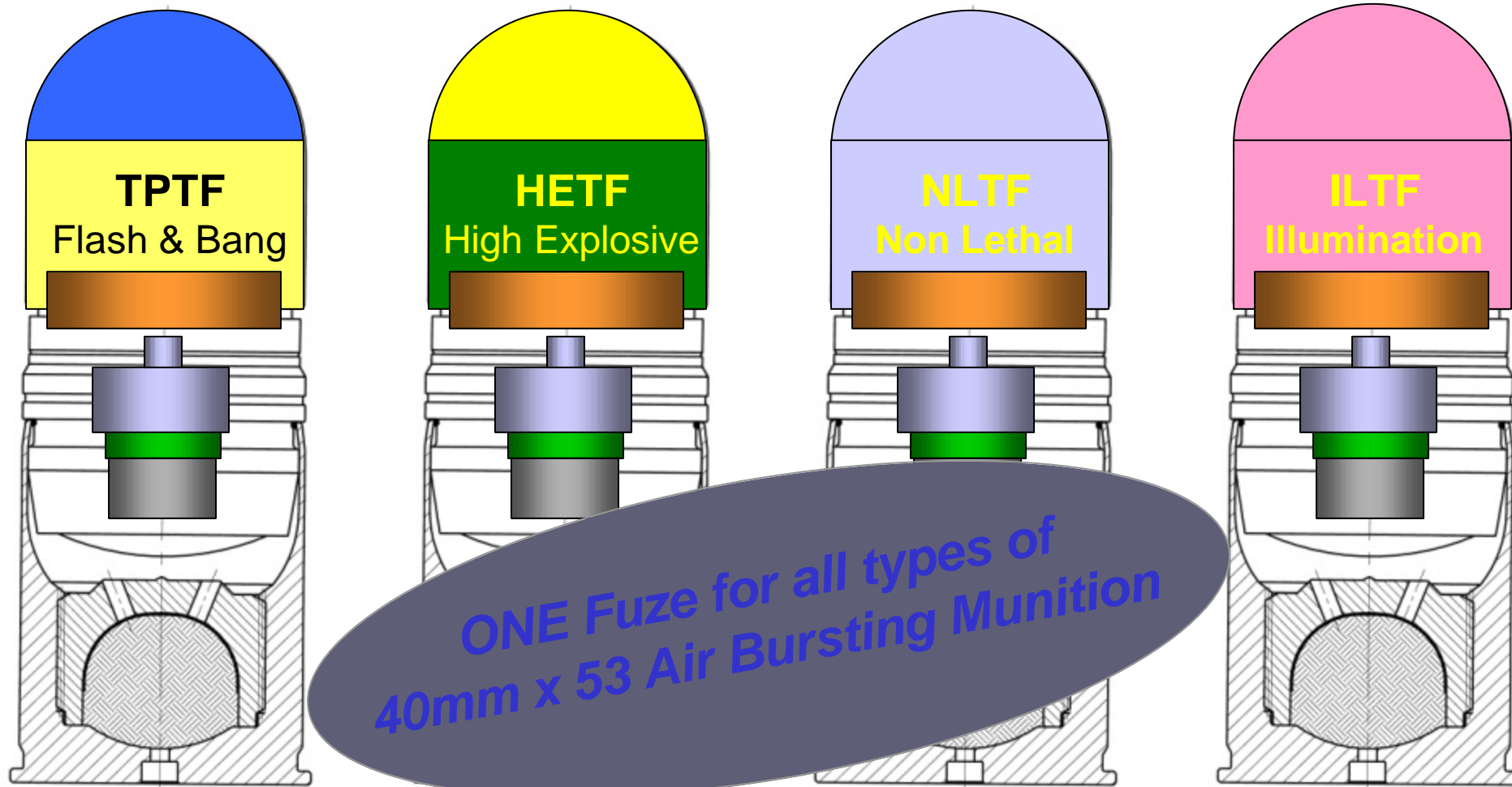

**ONE Fuze for all types of  
40mm x 53 Air Bursting Munition**

In Development

In Development

Future Type?

Future Type?



# 40mm x 53 Automatic Grenade Launchers: Air Bursting Munition HTE309

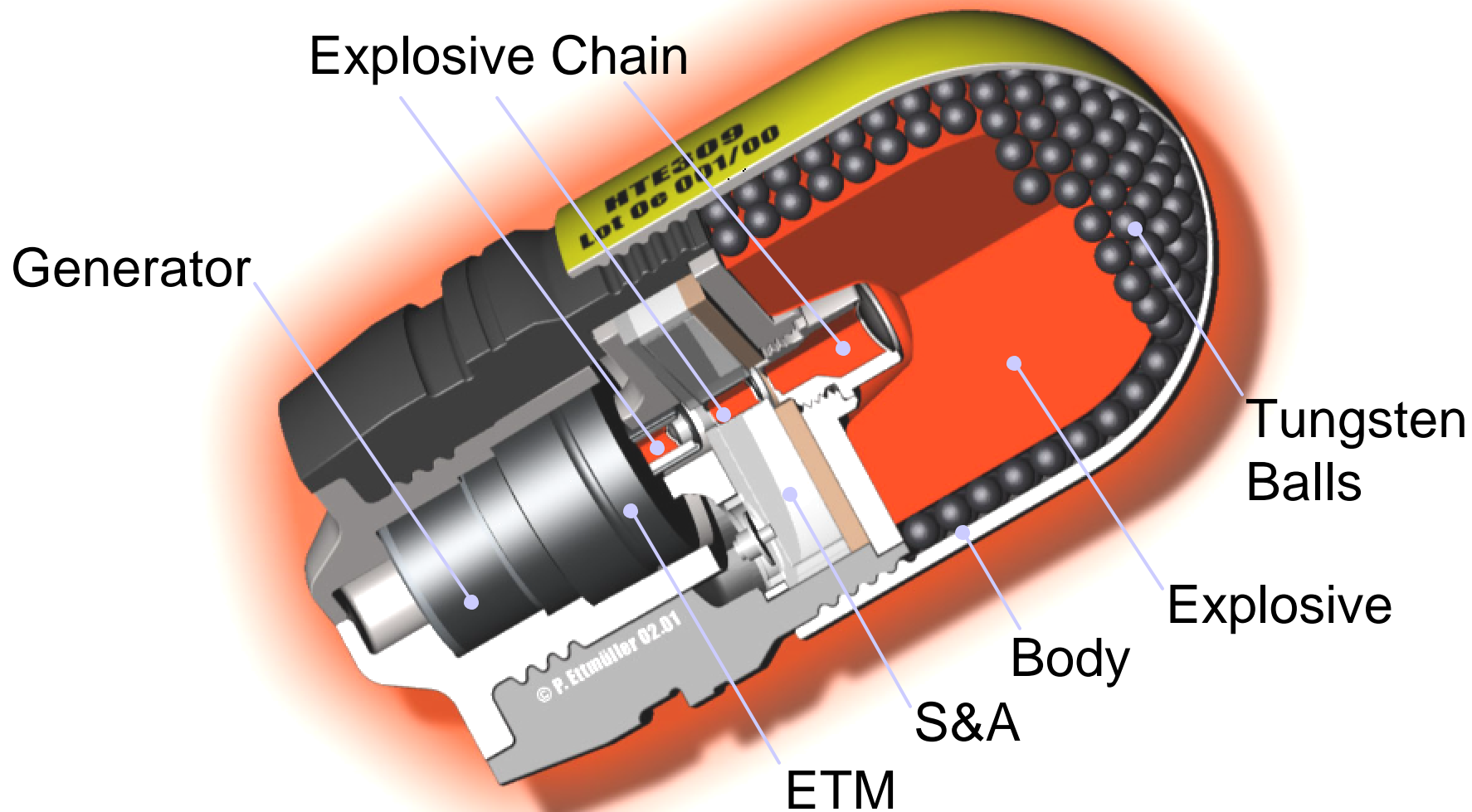

# Air Bursting Munition for AGL: Low Risk Concept

## Components from OCP ABM-Family

- Electronic Timer Module
- Setback Generator
- Squib

*Reliable components from  
Ahead fuze technology and  
40mm x 53 ammo*

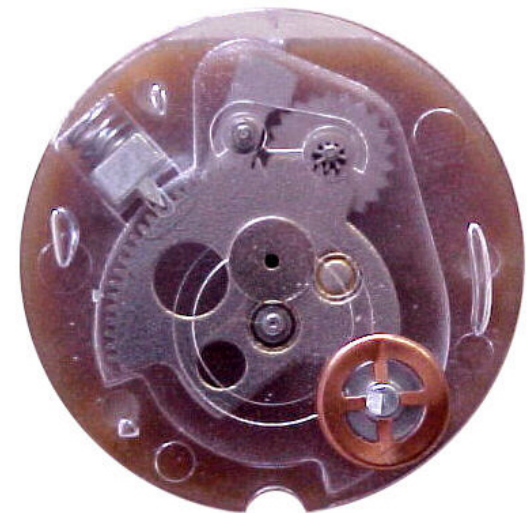

## Components from CAI 40mm Munition

- Safe and Arm System
- Cartridge Case
- Propellant

# Air Bursting Munition Concept Electronic Timer Module ETM

## Parameters & Features



- Operating range 40 m to 1600 m
- Self-Destruction (SD) 1600 m
- Programming of impact function On / Off
- Impact function & SD On if not programmed
- Sensitivity of impact sensor 2 mm Alum. Alloy
- Data transmission check if negative -> SD is On
- Absolutely ECM safe
- Without external energy the fuze still works on impact, even at graze angles

# Air Bursting Munition Concept Safe and Arm System

Centrifugal pin

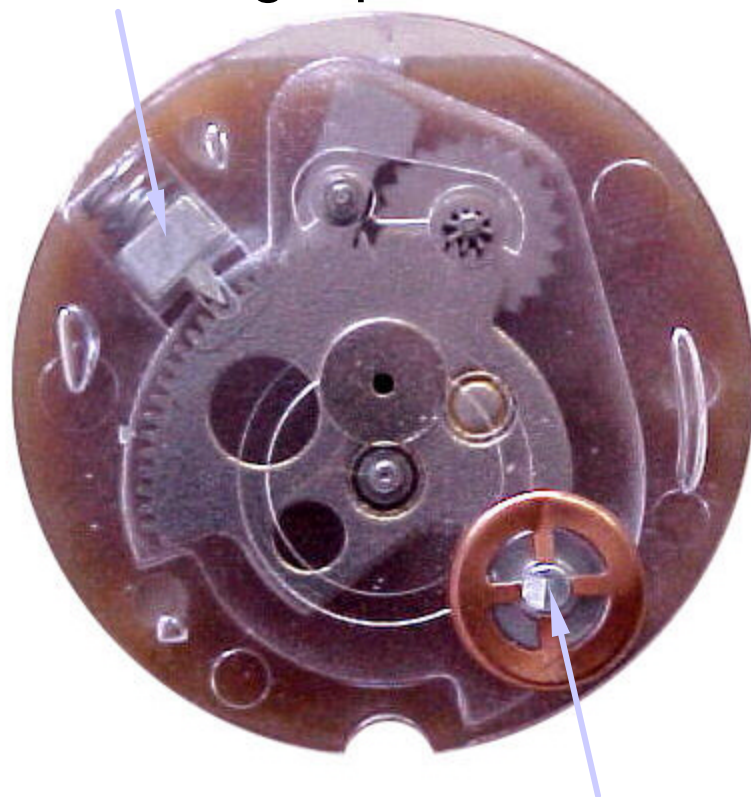

Setback pin

## SAFETIES

- Setback pin
- Centrifugal pin
- Setback generator
- Detonator Safety
- Mechanical muzzle safety    ₤ 18m
- Mechanical arming            ₤ 40m
- Electronic muzzle safety      ~ 40m



# 40mm x 53 Air Bursting Munition for AGL

## Summary of Main Features

Electronic Base Fuze:	Ahead technology
Programmable at Muzzle:	Fuze time / impact sensor
Arming Time:	Mechanically & electronically driven
Safe and Arm:	Mechanically driven (Stanag)
Propulsion System:	Accurate / low muzzle velocity variation
Exterior Ballistics:	Compatible with standard ballistics
Point Detonating:	Piezo impact sensor / graze angle capability
Impact Sensor:	<ul style="list-style-type: none"><li>- Automatically On w/o fuze programming</li><li>- Switched Off function programmable</li></ul>
Warhead:	HE pre-fragmentation / large footprint / high lethality (forward and lateral fragment release)
Self-Destruct Function:	Automatically On when no fuze programming

# 40mm x 53 ABM HTE309: Usage Operation Modes

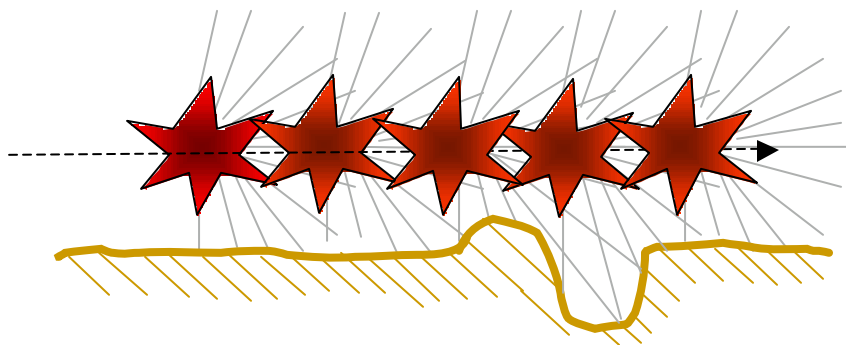

„String of Pearls“

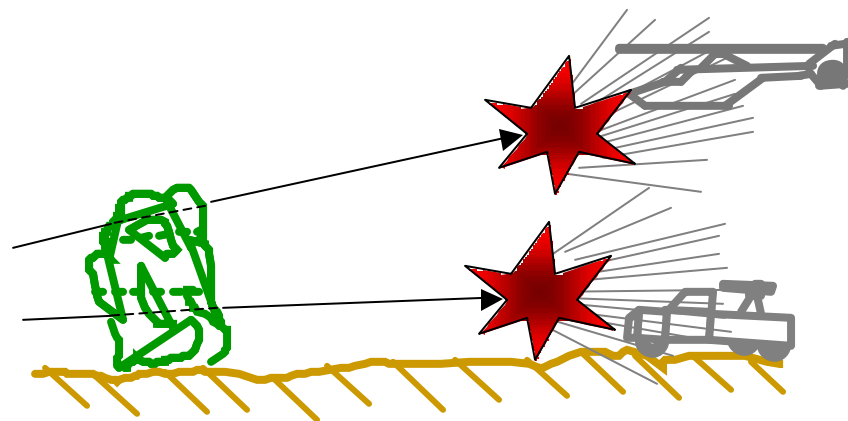

Air Burst w/PD Function Off

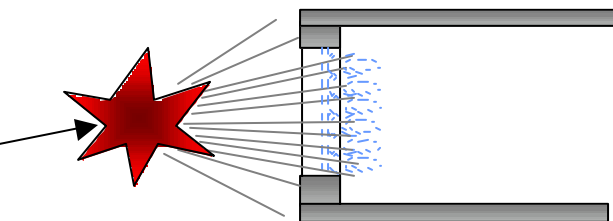

Air Burst against  
Openings

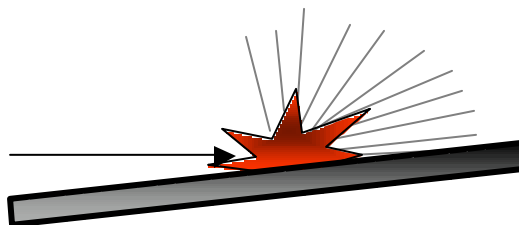

Point Detonating  
PD Function On

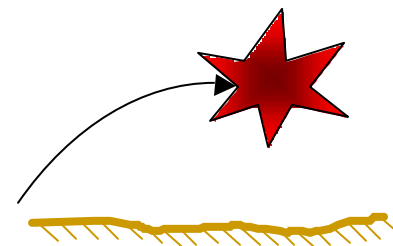

Self Destruct

# Air Bursting Munition Analysis

## Effectiveness Pattern: Nose vs Base Fuze

scale: black bar reference = 5m

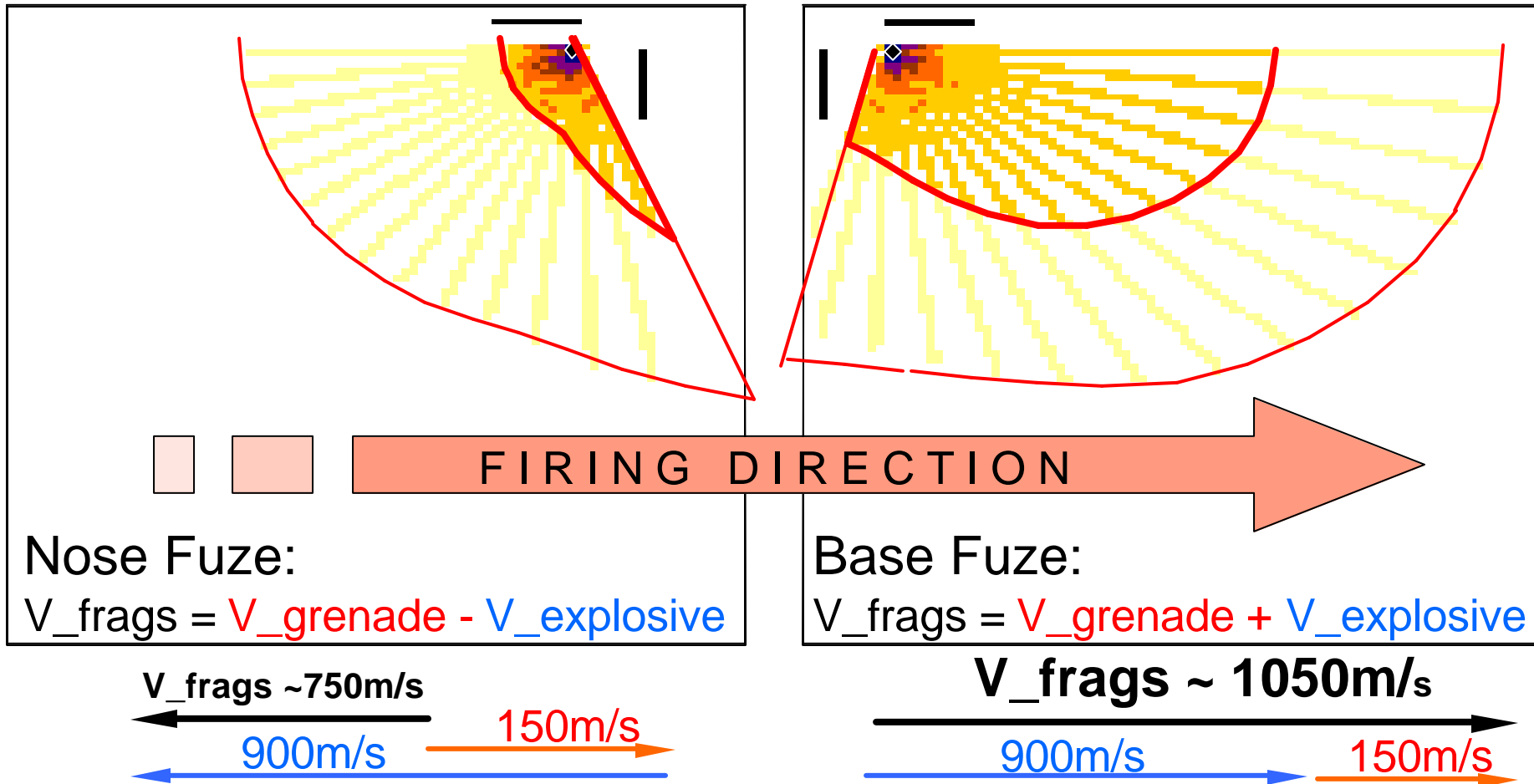

# 40mm x 53 ABM HTE309: Pre-Fragmented High Explosive Warhead

Fragments  
# of W-Balls

Tungsten Balls  
Max. 400

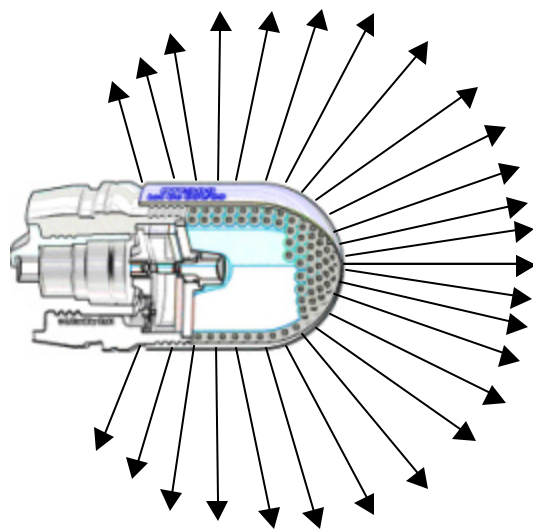

Ball Mass

0.25g each

Payload Mass

Max. 100 g

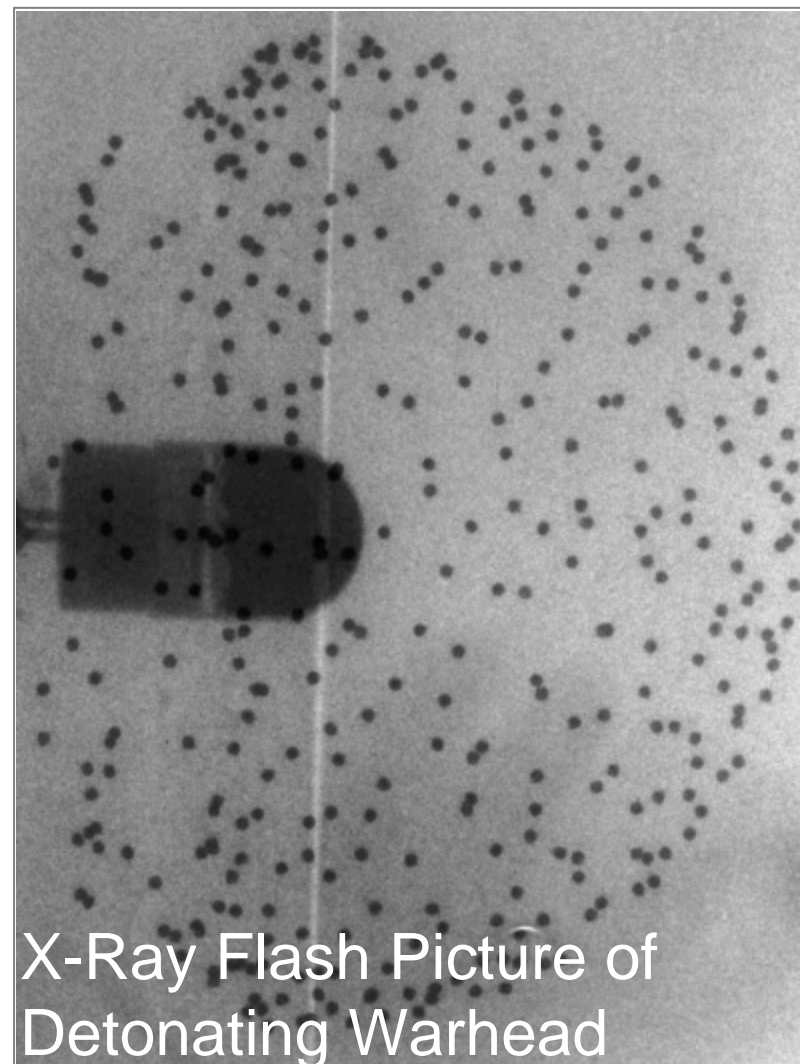

X-Ray Flash Picture of  
Detonating Warhead



# Air Bursting Mmunition Analysis "Behind Wall" Lethal Area

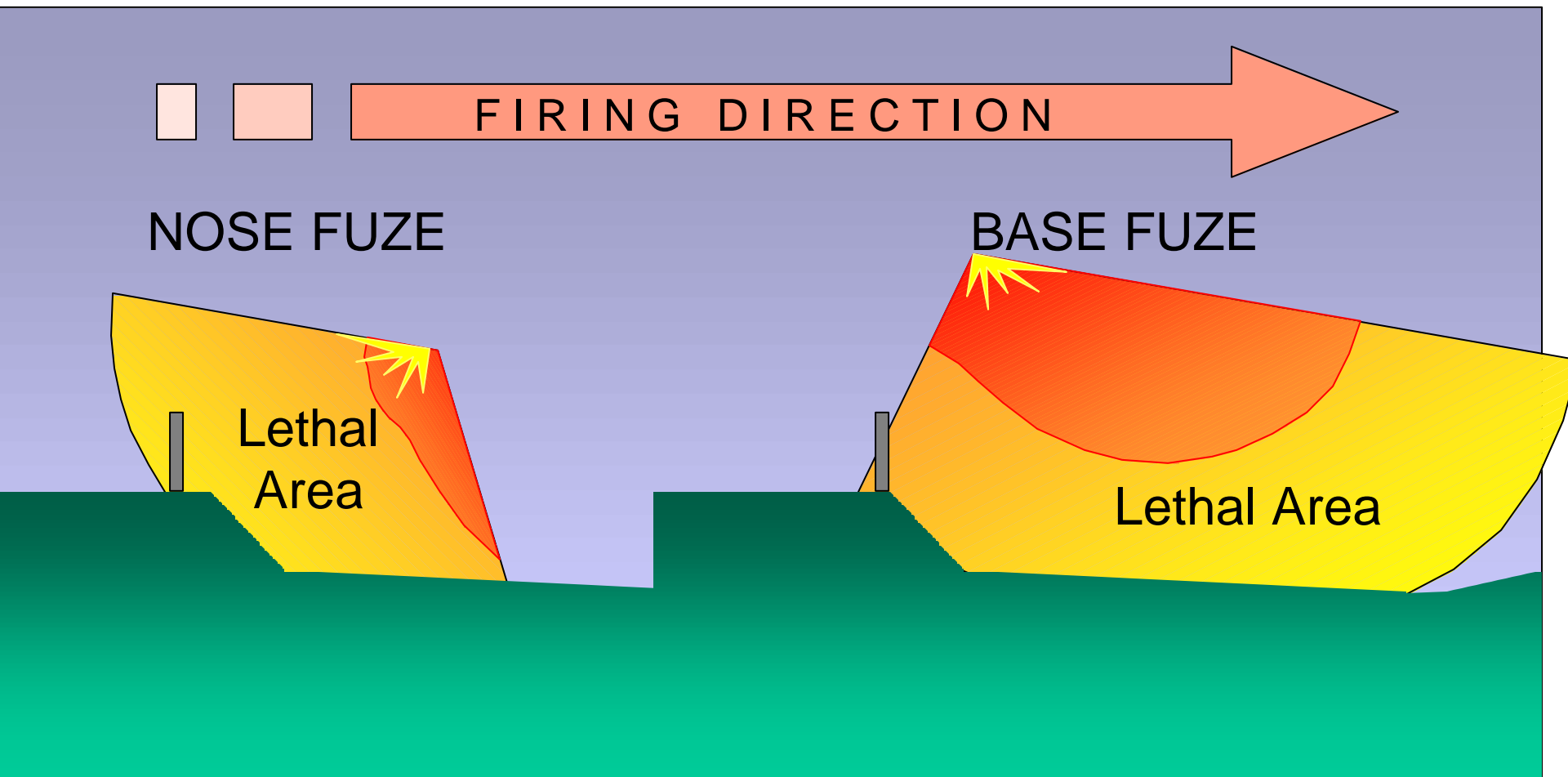

# Air Bursting Mmunition Analysis

## Max. Allowable Error in the Open - Nose Fuze

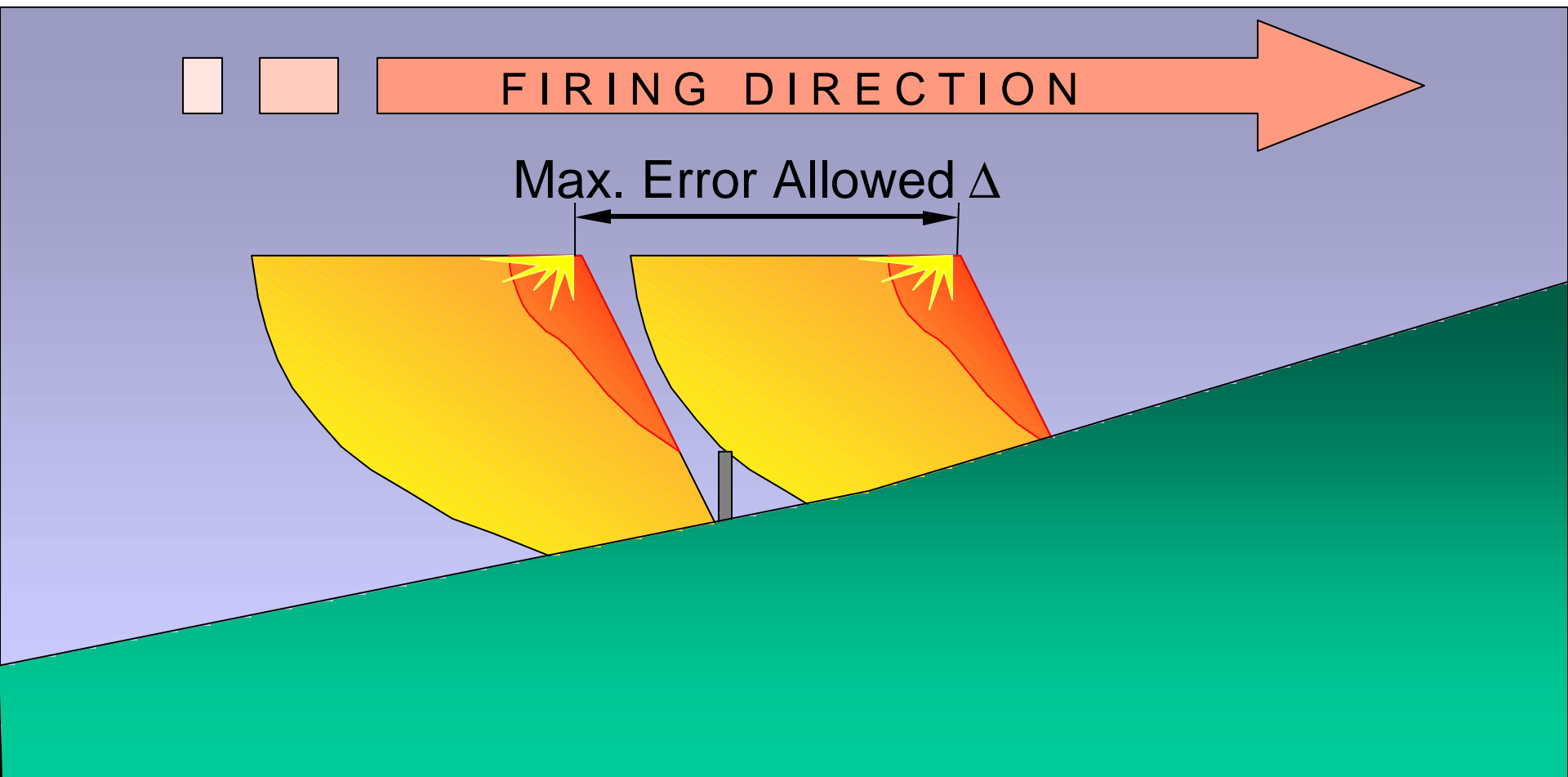

# Air Bursting Mmunition Analysis

## Max. Allowable Error in the Open - Base Fuze

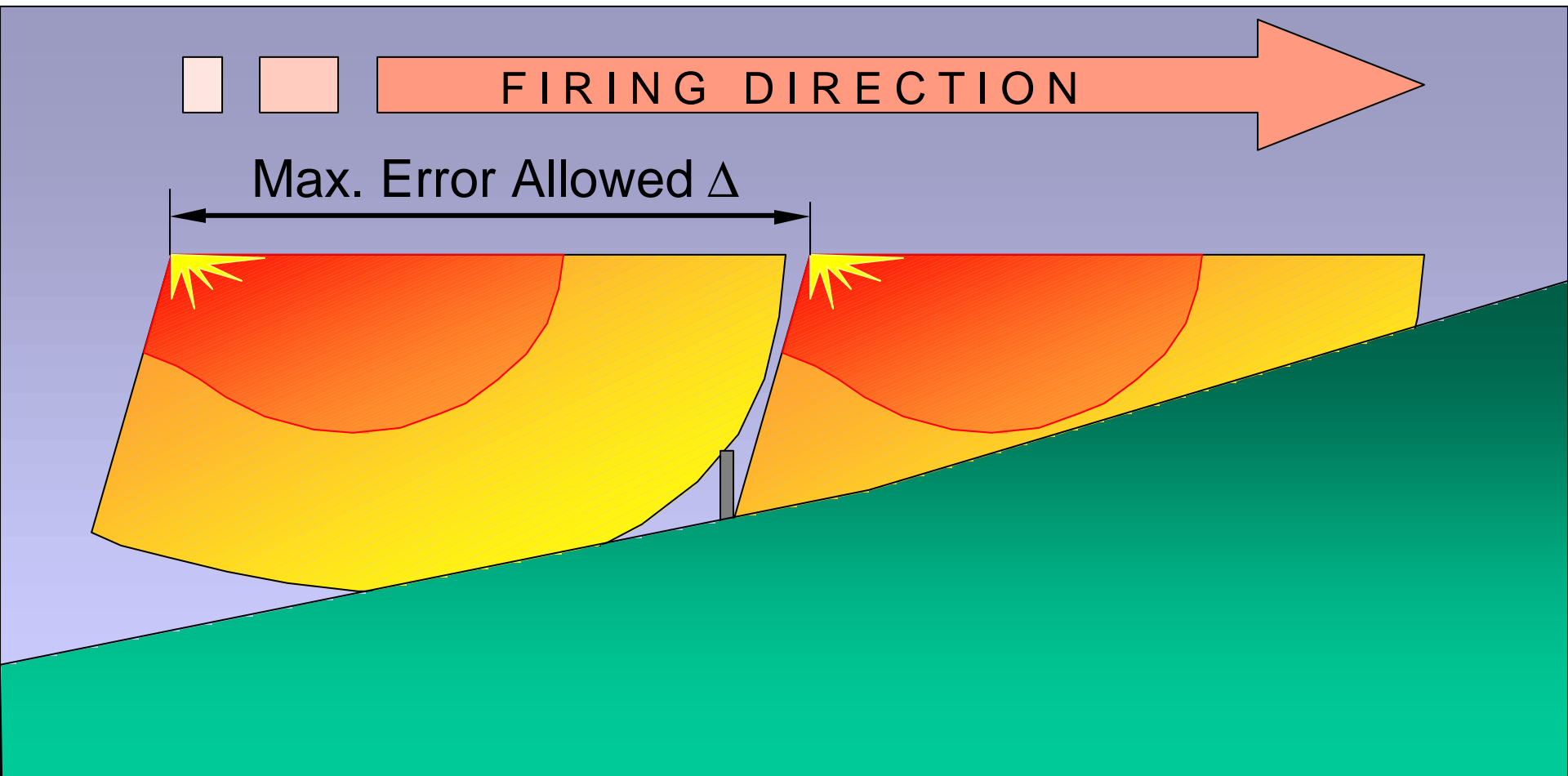

# Air Bursting Munition Analysis

## Max. Allowable Error Against Openings - N.F.

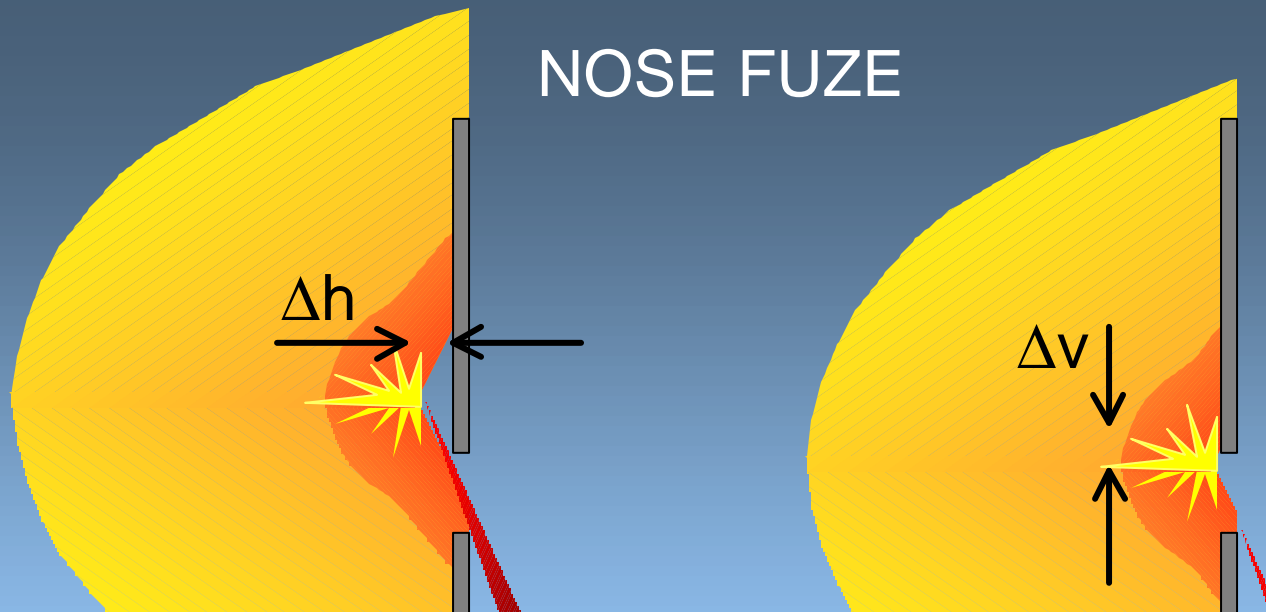

# Air Bursting Munition Analysis

## Max. Allowable Error Against Openings - B.F.

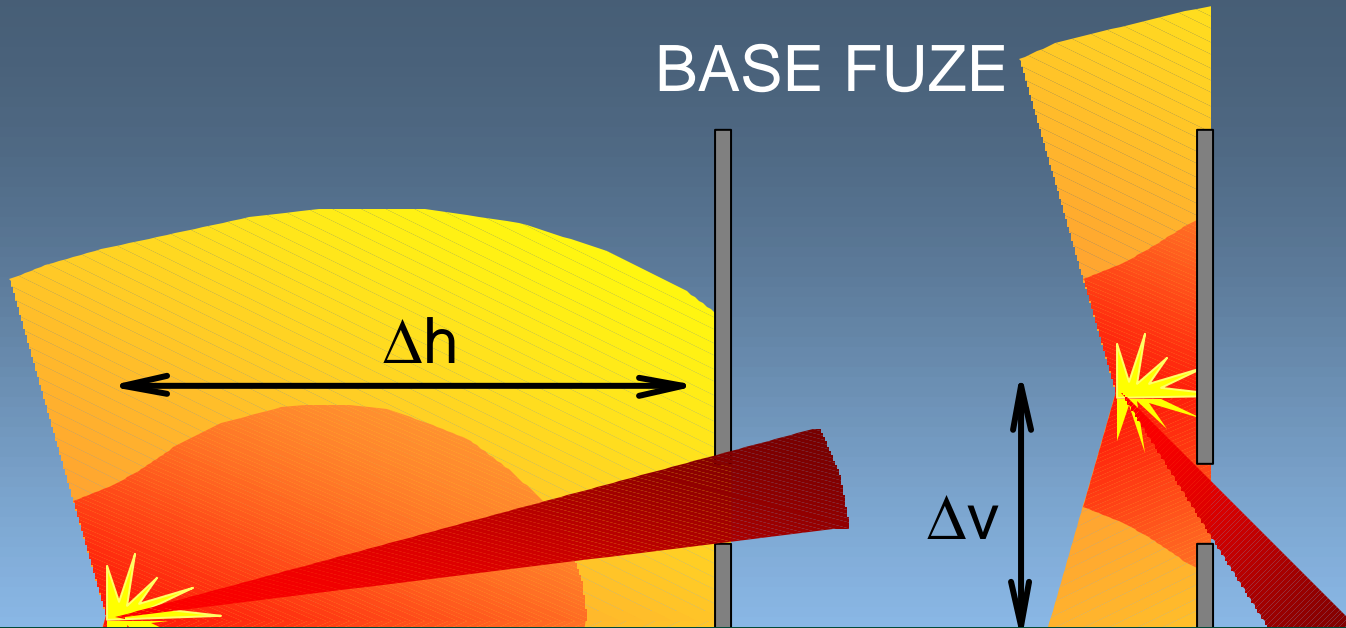

# Terminal Ballistics of ABM for AGL: Base Fuze vs Nose Fuze Concept

## With Base Fuze:

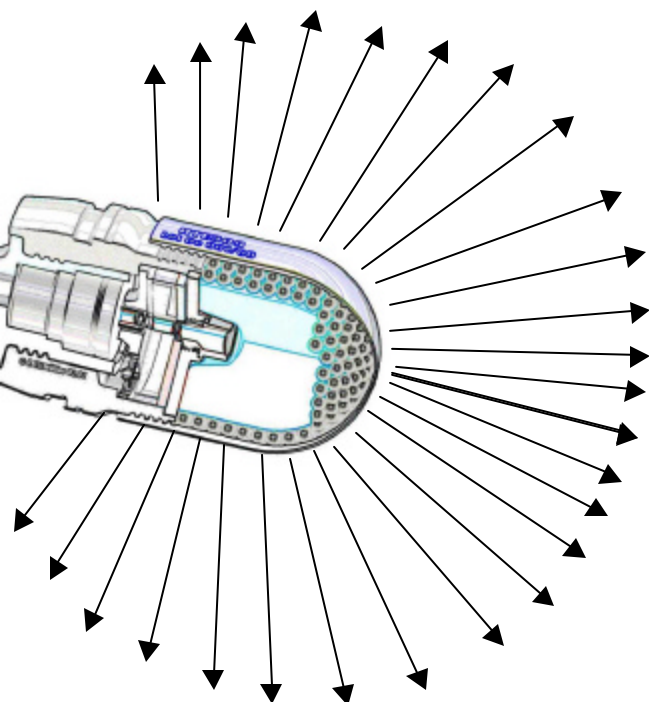

- Lethal area much larger:  
Better hit probability.
- Addition of velocity vectors:  
Higher fragment velocity; i.e. lethality.
- Detonation wave acting directly on target:  
Better performance on impact.
- Larger “Behind Wall” lethal area
- Few low energetic frags flying backwards:  
Higher safety at short range.

# 40mm x 53 ABM HTE309: Warhead Function

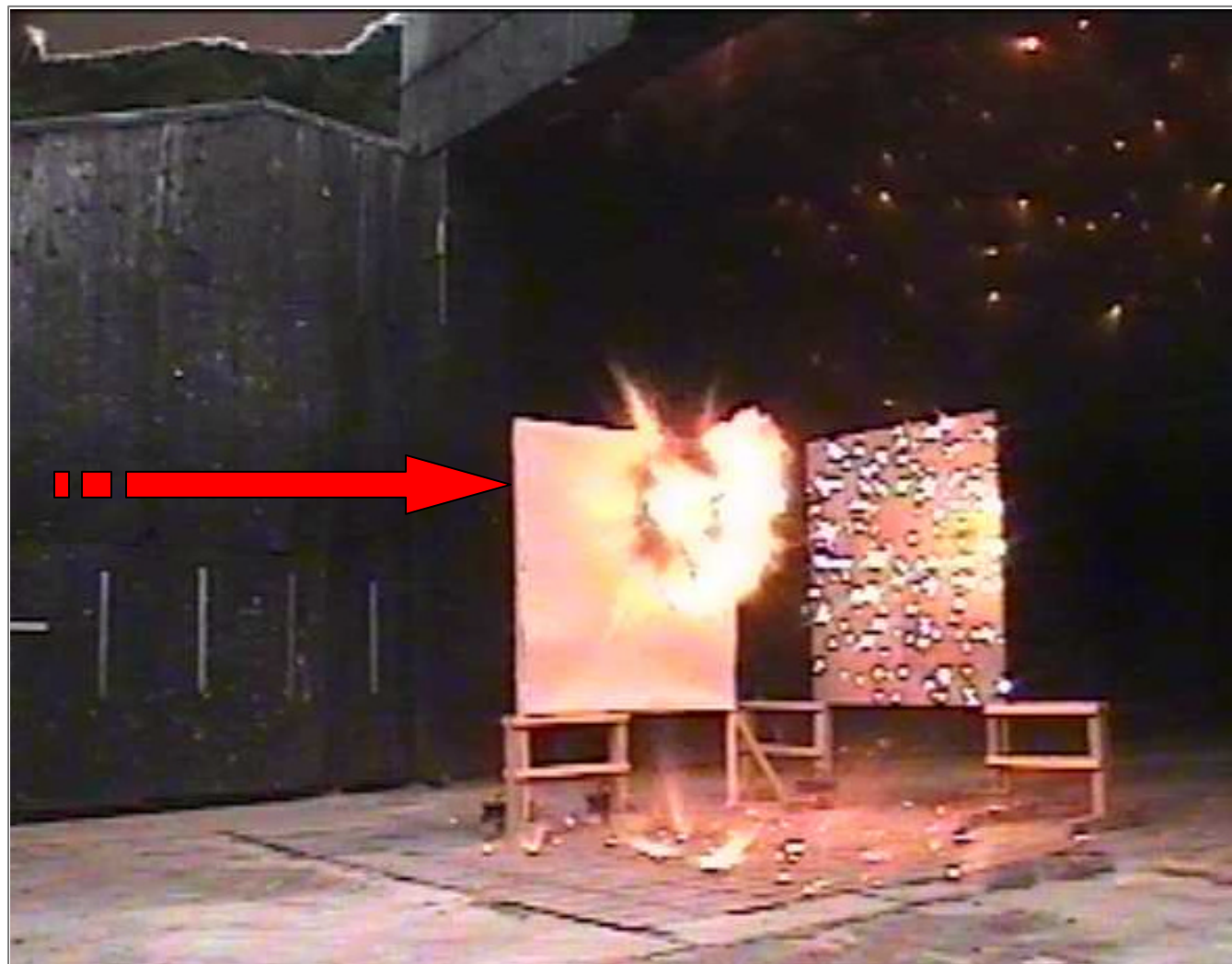
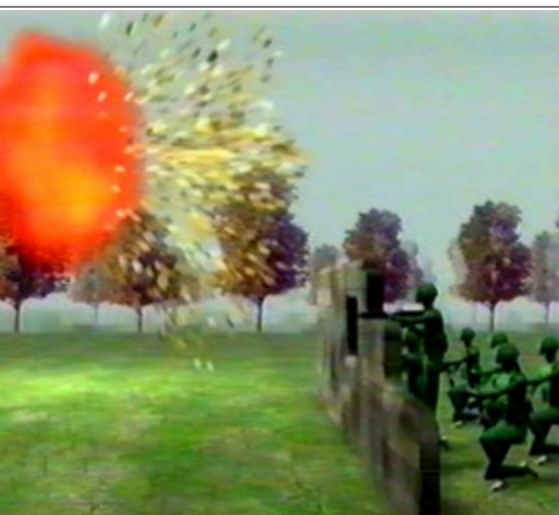

# 40mm x 53 ABM HTE309: Firing Tests

Slow Motion Videos  
of single shot  
and burst firings  
up to 570 Rd/min

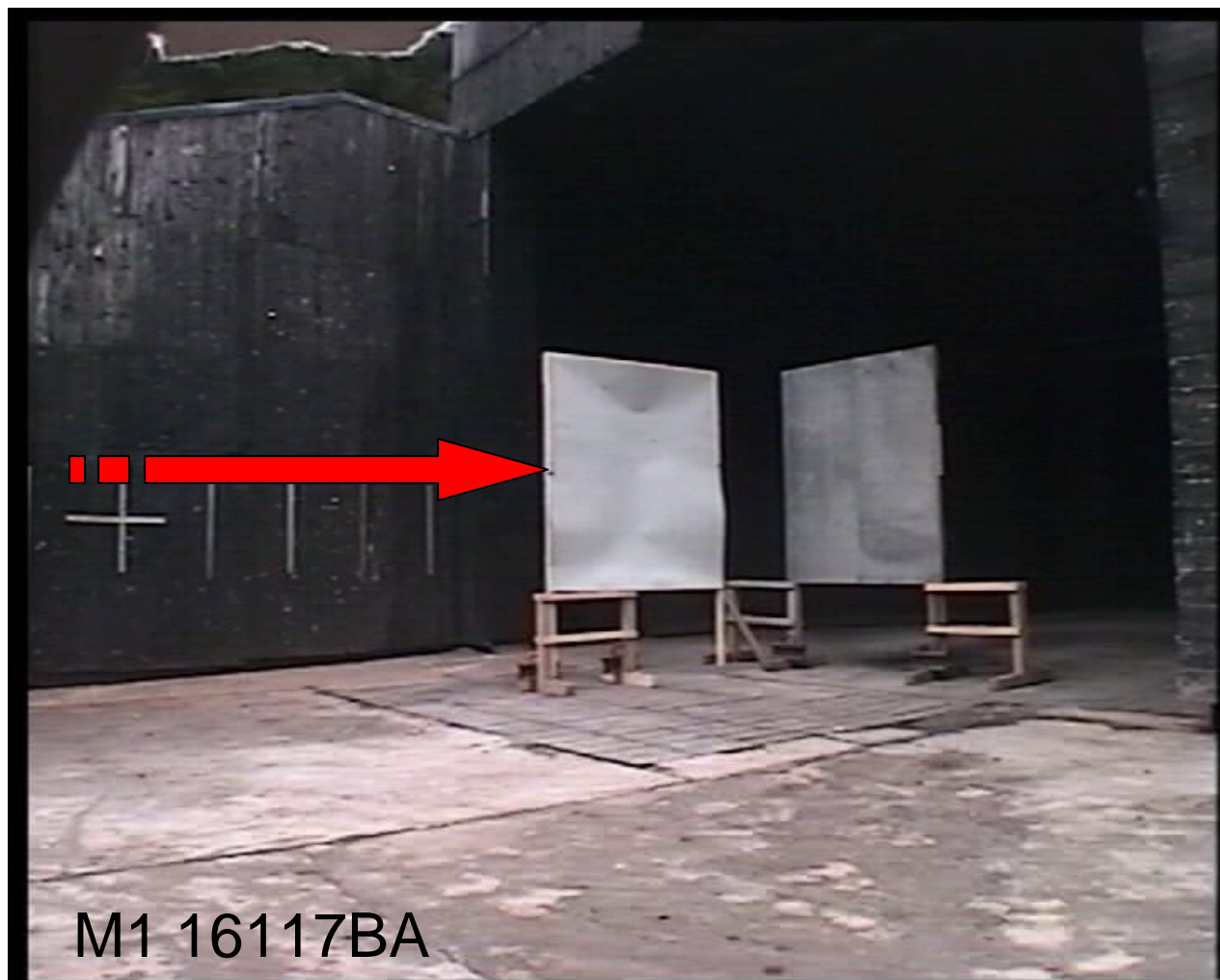





# 40mm x 53 Air Bursting Munition System for AGL: Program Mile Stones

- Start R&D (ABMS) Early 1998
- Start Partnership OCP - ST Kinetics Sept. 2000
- Contract Signed with FMV-Sweden Dec. 2000
- Prototype Delivery FMV-Sweden May 2002
- Product Qualification completed Mid 2003
- Start Serial Production Early 2004