

SkyRanger

Multi Mission
Vehicle Armament &
Air Burst Munition
for
Expeditionary Warfare
Force Protection

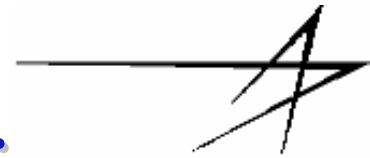

Conflict Management Dynamics



Cold War

- Clear Rules
- Doctrines
- Plans



Hot War

- Three Block War
- Asymmetric & Symmetric Threats
- Expeditionary
- Rapid Deployment
- Dynamic Planning

Turreted Gun Limitations



STRYKER elevation +15, Depression -5

M1/M1 A2 elevation +20, Depression -10

BFV elevation +60, Depression -10

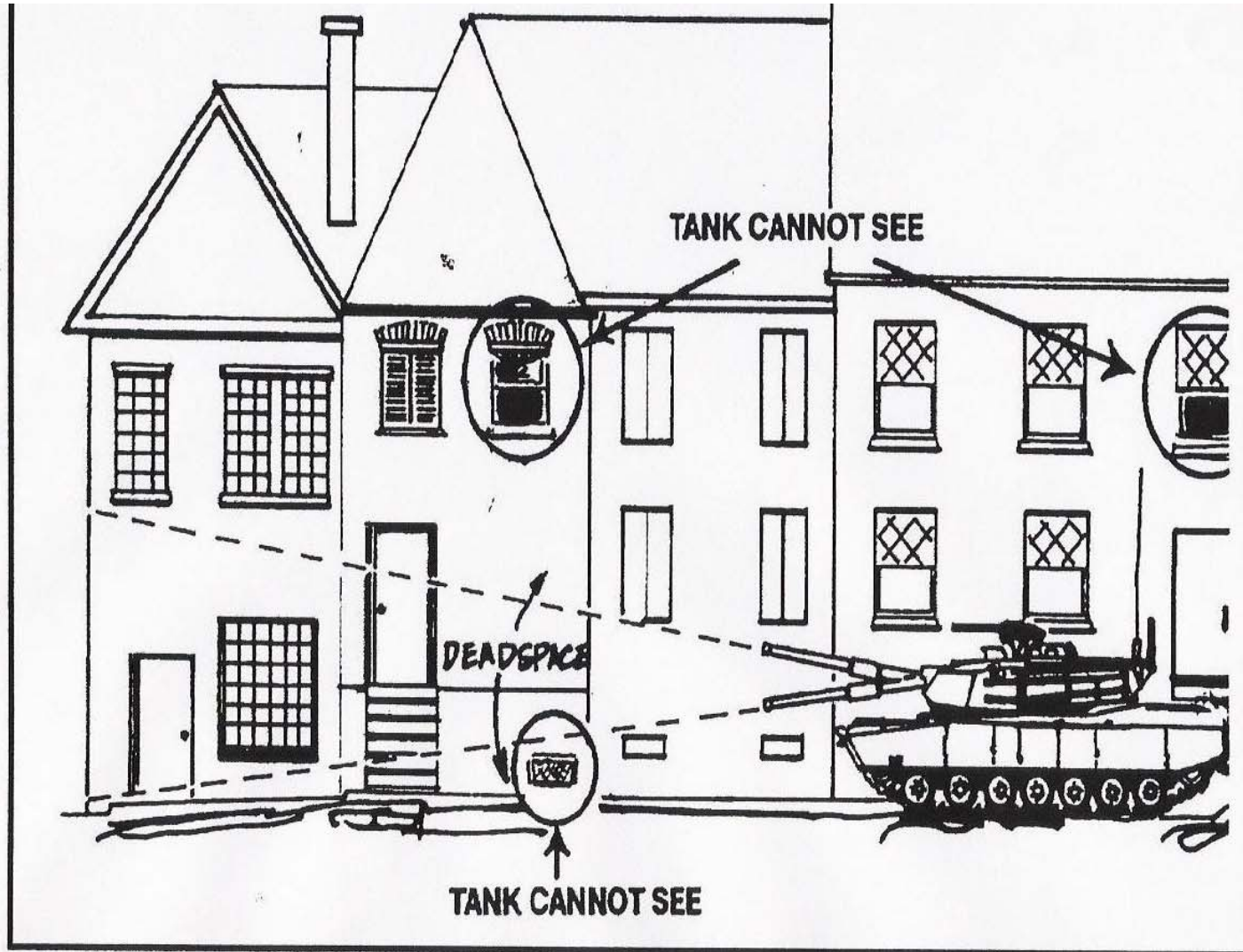

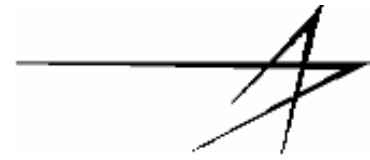

SkyRanger Gun System



Typical Layout

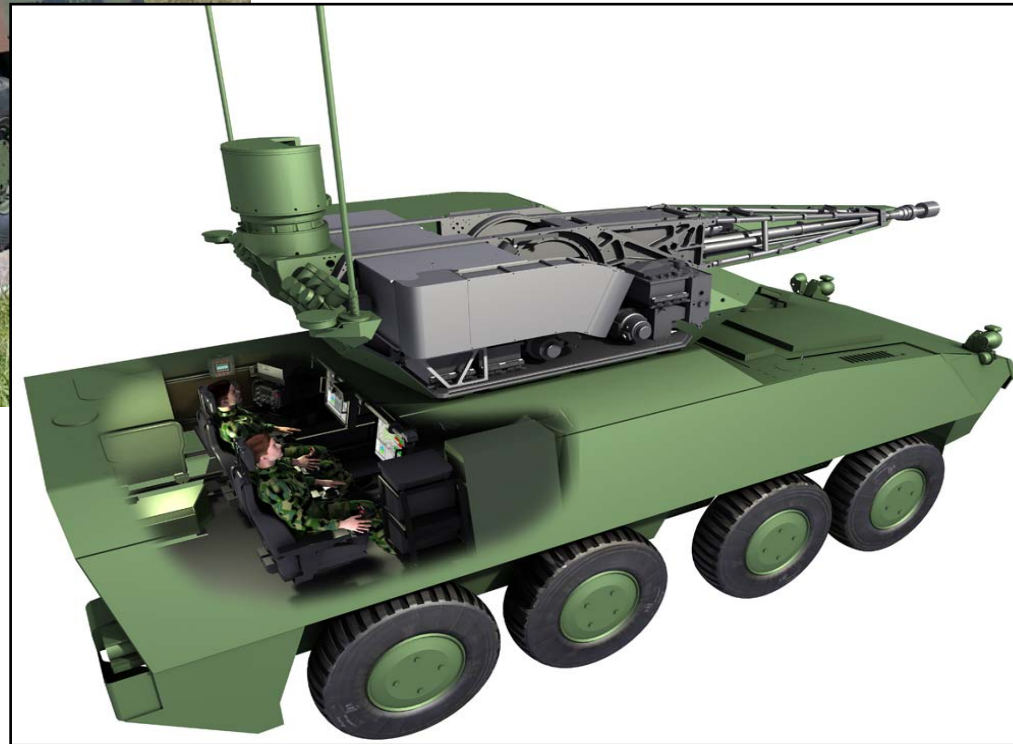

Example of Installation

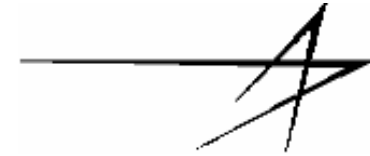

35mm Ahead Turret

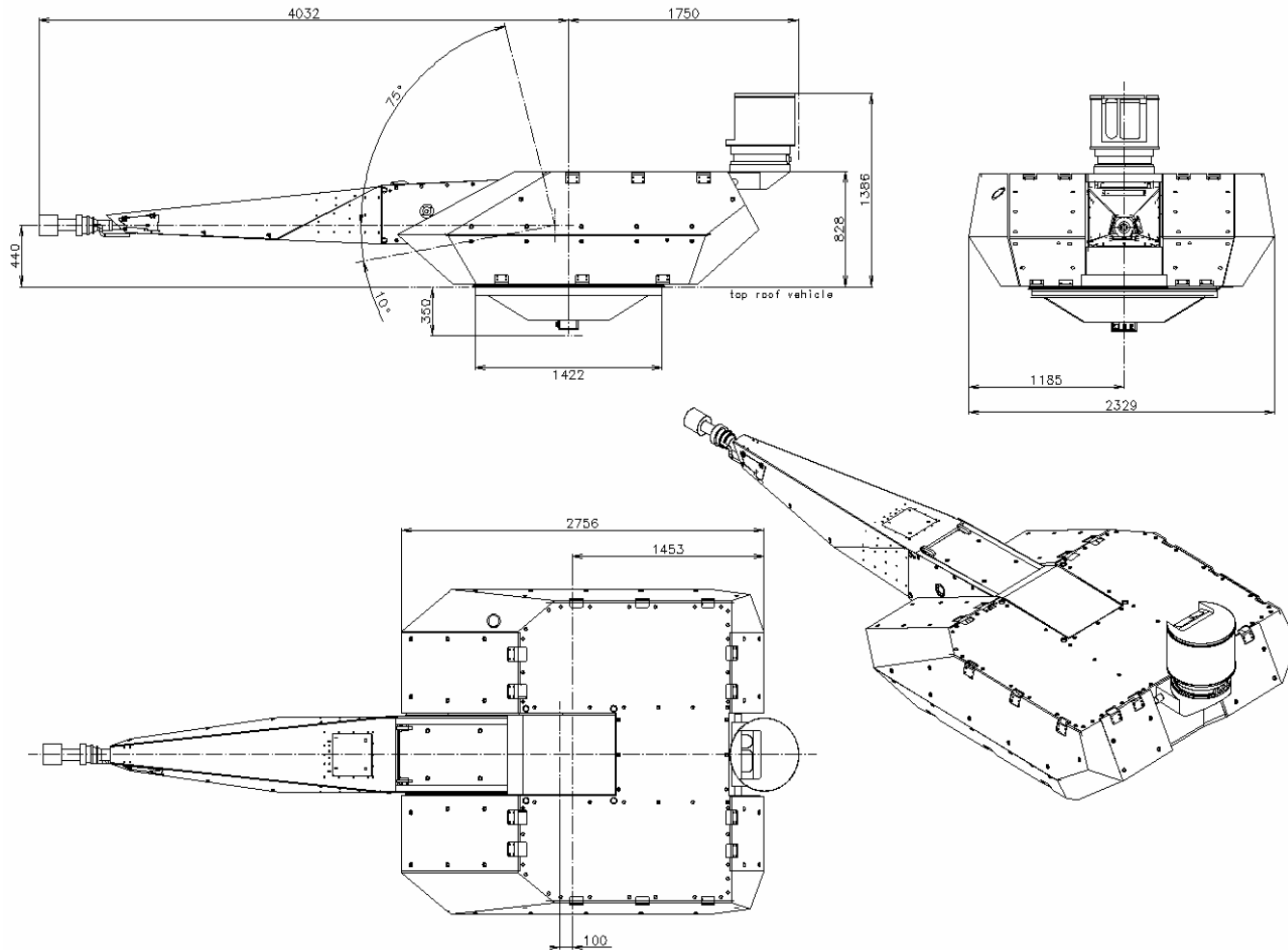

35 mm Revolver Cannon & Ahead Ammunition

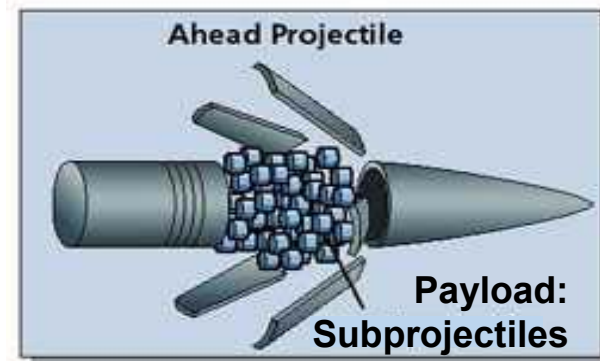
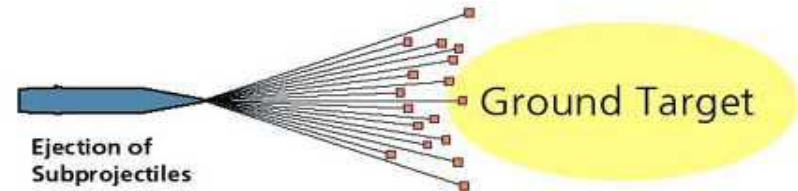
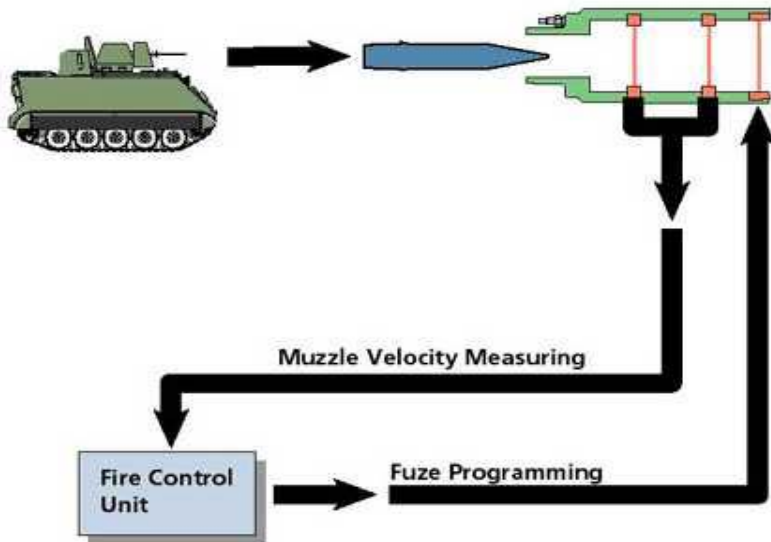
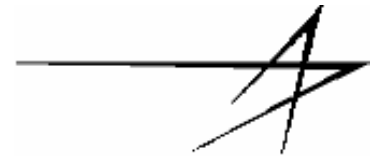

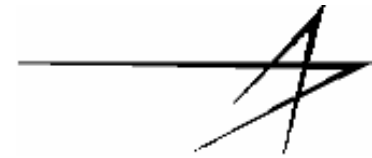

35mm Air Burst Munition

Kinetic Energy Time Fuze (ABM-KETF)

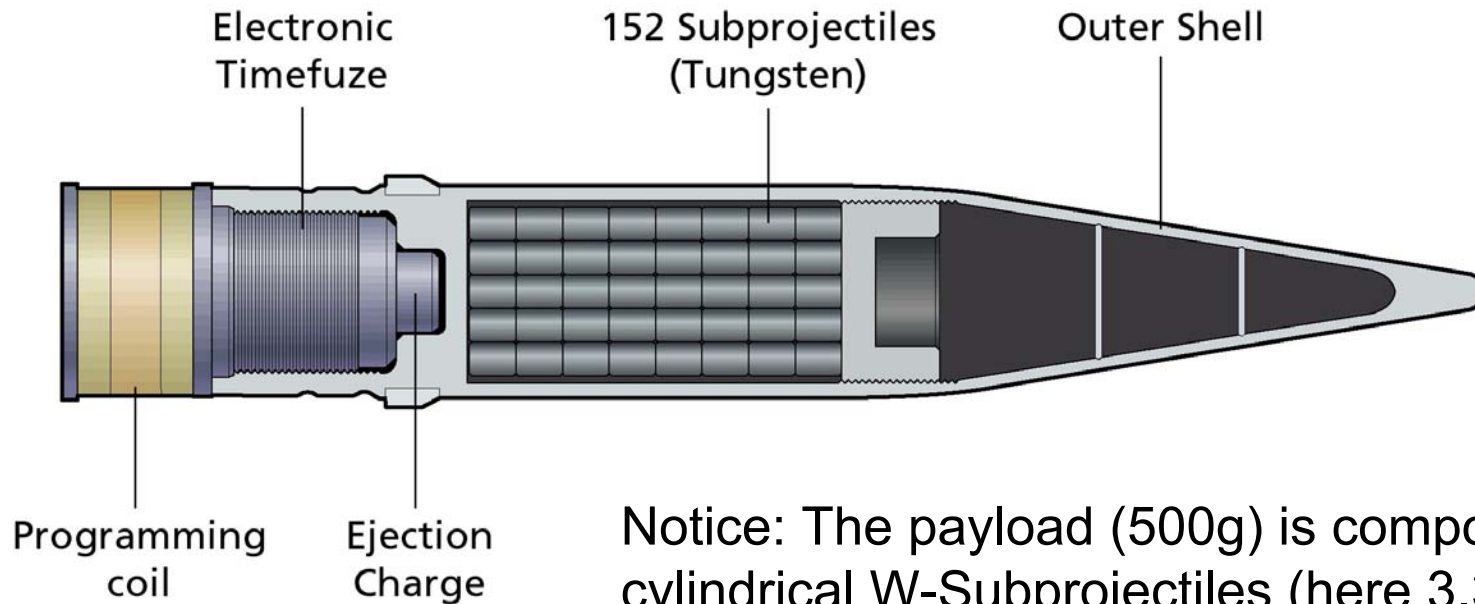

Notice: The payload (500g) is composed of cylindrical W-Subprojectiles (here 3.3 g each). For engagements other than AA (e.g. G-to-G) the mass of the subprojectiles can be reduced accordingly (e.g. 1 to 1.5 g)

Effective against UAVs & Helicopters

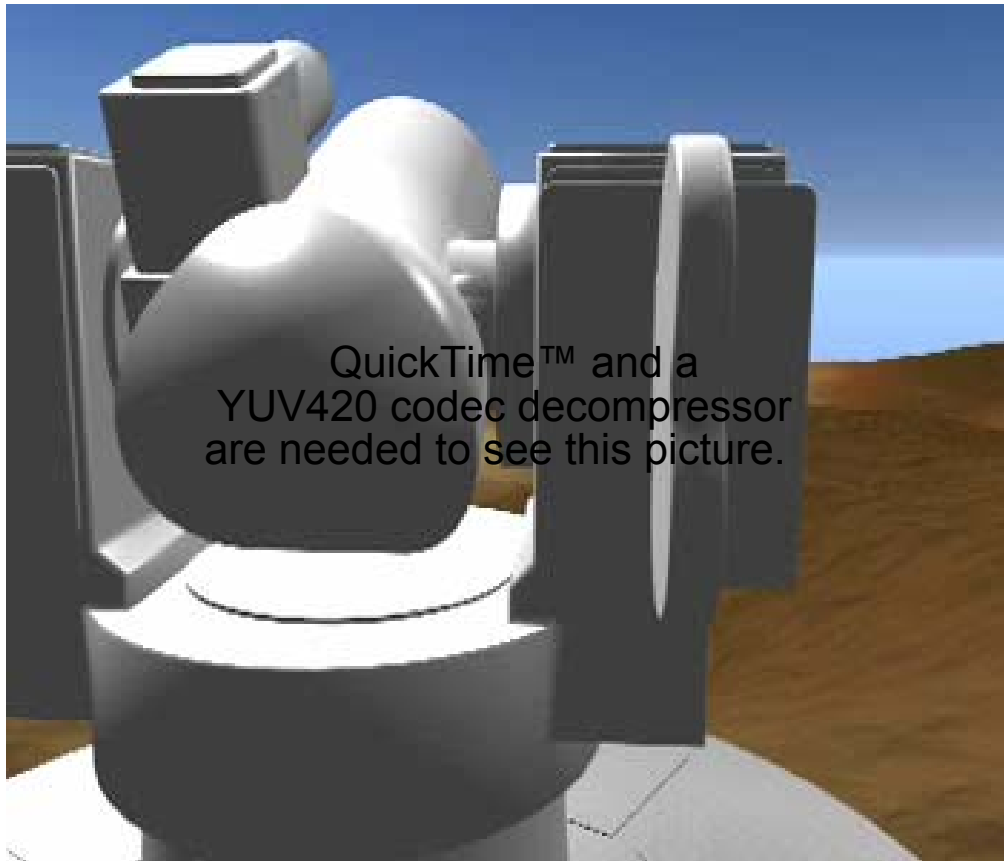
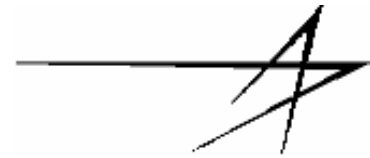

China Lake NAWS July 2004

Helicopter Target (UH-1, Static)

Effectiveness of 35 mm Ahead Ammunition

- 2 Shots
- Range: 1500 m
- Entry Side
- Ref.: APG/Oct. 98



Effectively Neutralizes Heavy Armor

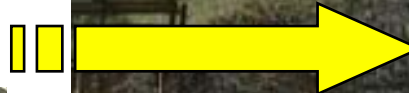
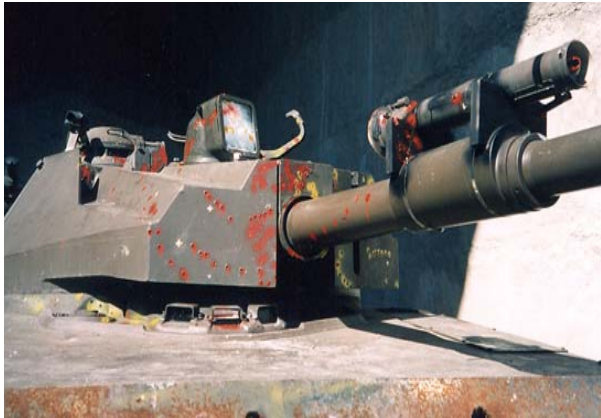
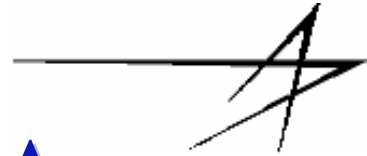

Effective against ATW Positions

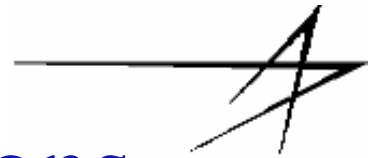

U. S. Army Breaching Techniques

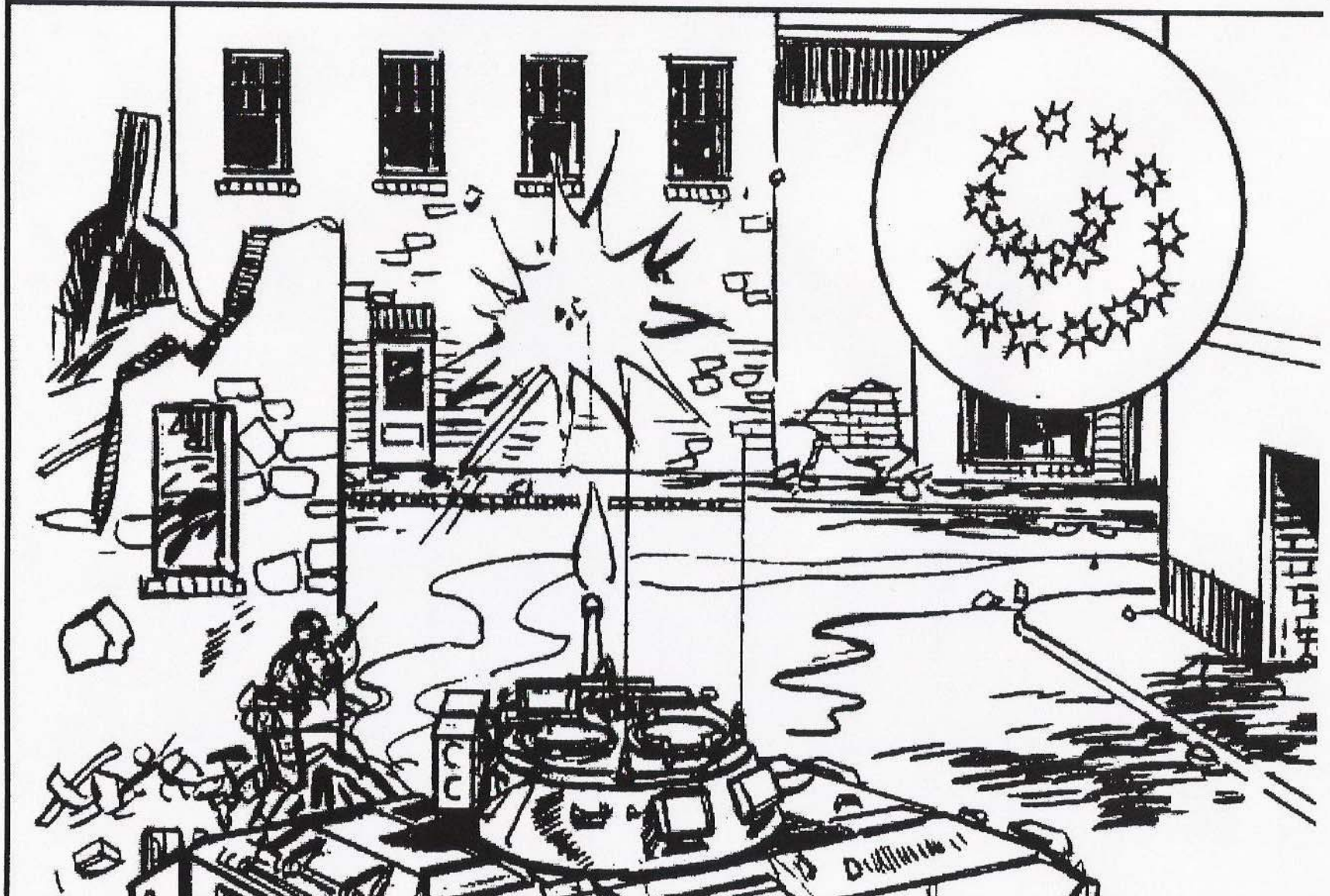

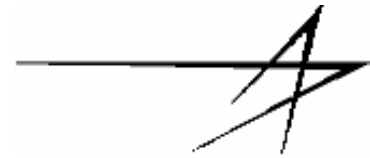

Breaching Fire

8" Concrete Wall

Double Steel-Structure Reinforced

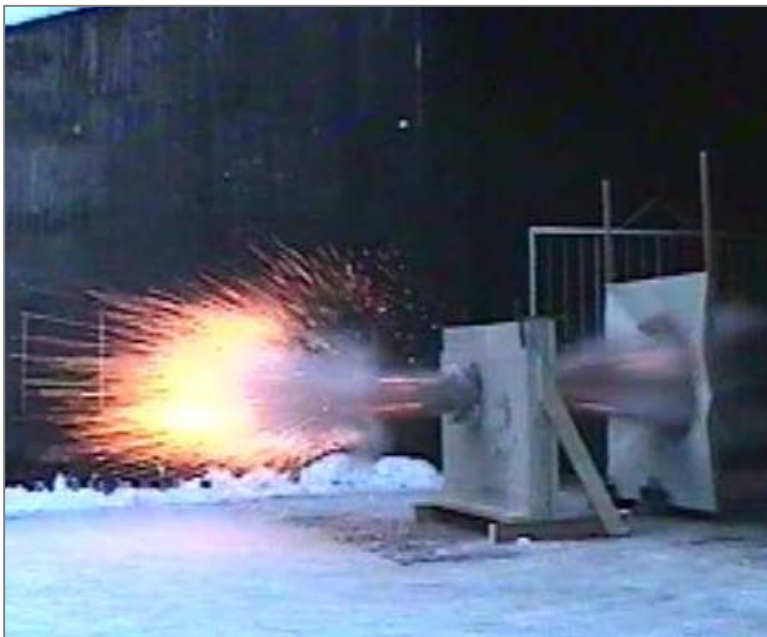

Video: M1 15962BA

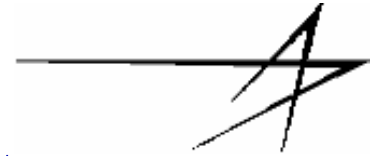

Base Defence – Counter Mortar

Demonstrated 12.2004

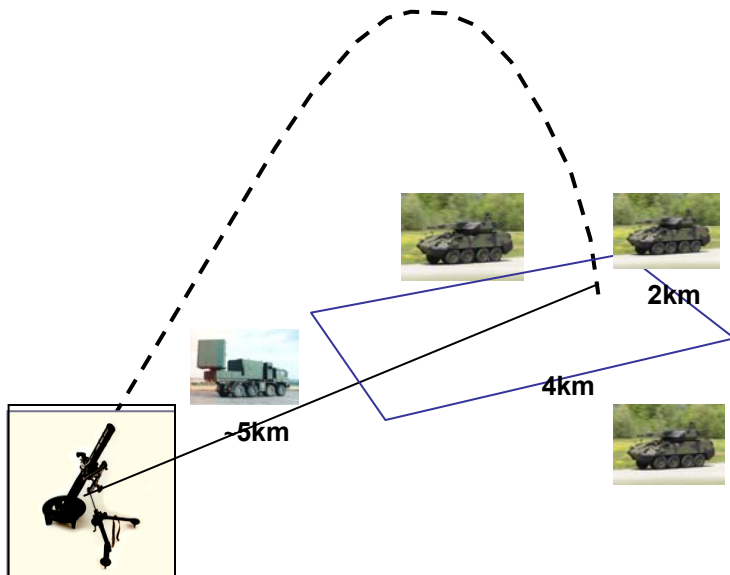

QuickTime™ and a
YUV420 codec decompressor
are needed to see this picture.

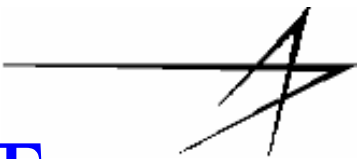

Ahead Lethality – Dismounted Troops

4 Rds @ 135 Subprojectiles = 540 SP

Total: 107 Plate Perforations (~ 20%)

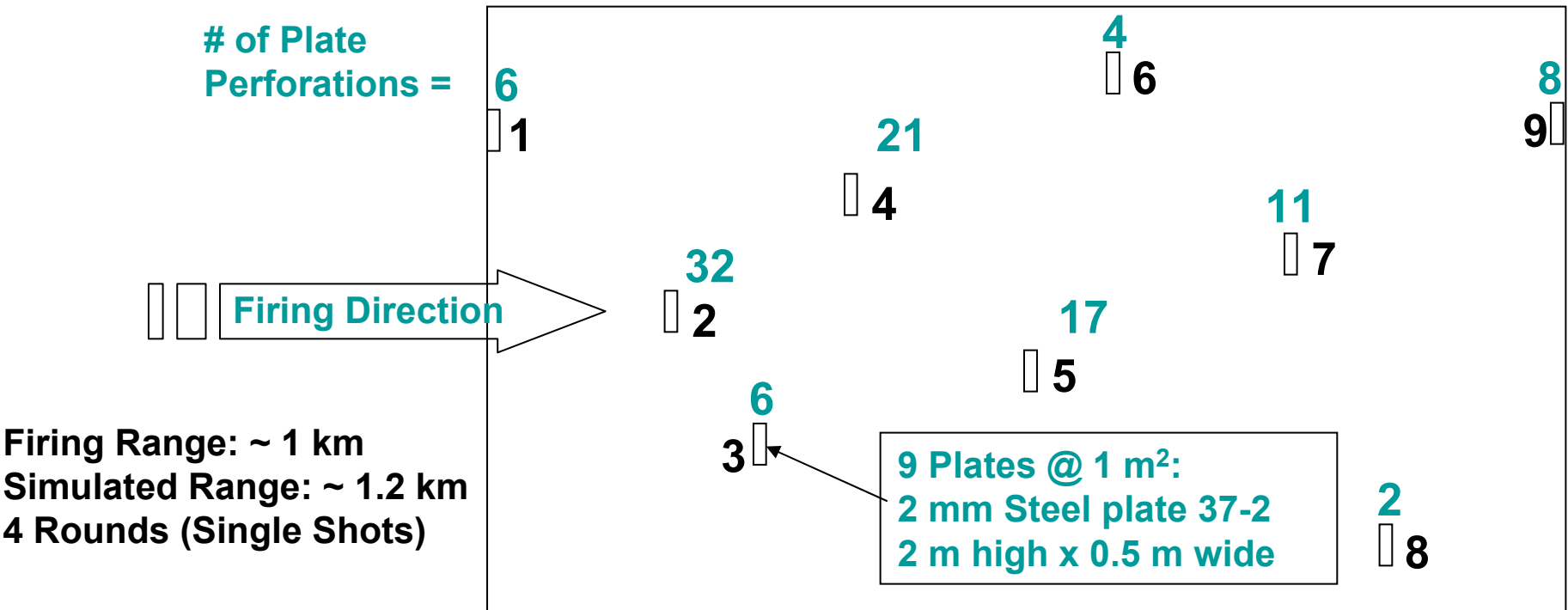

Target Area: 10 (width) x 30 (depth) m

The target area is 27 m higher than the gun muzzle



ABM Ground Operation Modes

Point Target (incl. ATGW-Bunker, Prone & Covered Troops, MBT, Helicopter):

Gun

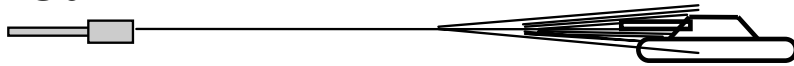

Area Target (Diffused Targets):

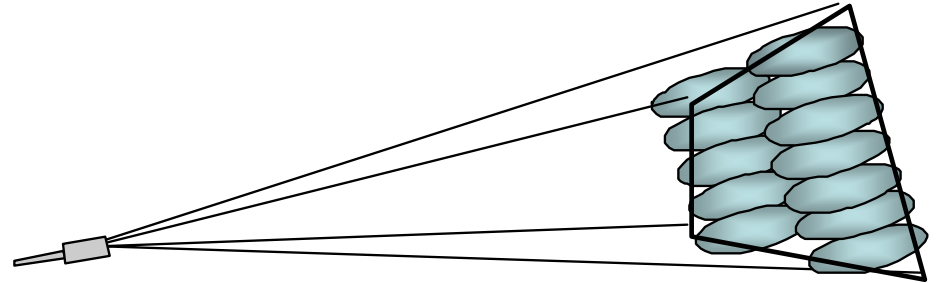

Linear Target
(e.g. road with vehicles):

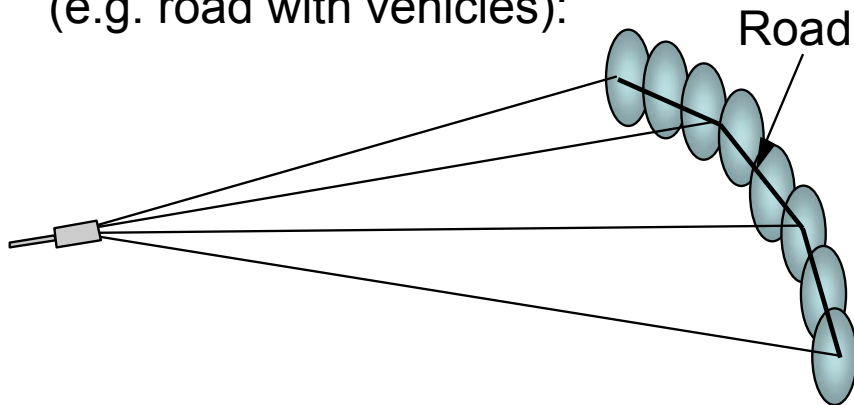

Pre-Determined Air Space
(e.g. swarm of helicopters):

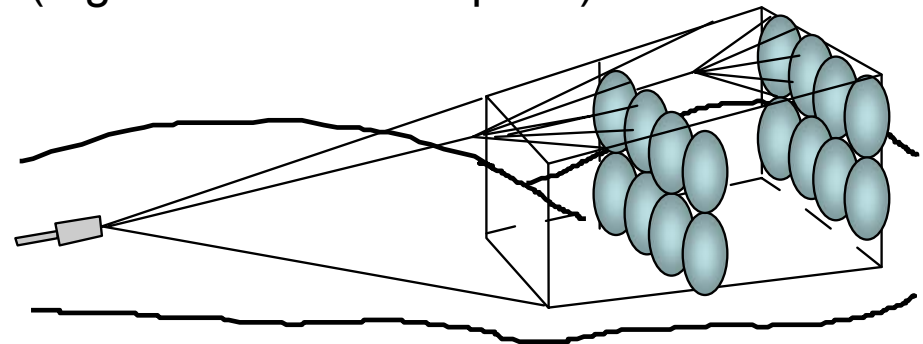

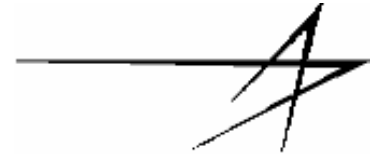

SkyRanger Capabilities

- Automatic target detection and tracking
- 35mm Revolver Cannon (1000 rds/min.)
- Independent line of sight
- Air and ground target engagements
- Small target engagement capability
- 200 rounds ready to fire ammo
- Dual feed
- Rapid single shot (200 rds/min.)
- Unmanned turret
- Navigation system
- Battery powered
- Low mass / Turret: 3.4 + 0.8 inside equipment (tons)

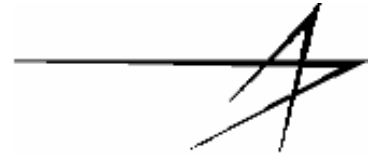

Questions?

Contact information:

Andrew A. Bradick

6858 Old Dominion Dr,

Suite 210

McLean Va 22101

Tel 703 448 1947 Fax –1961 email

abconsult@yahoo.com