

# **Moving to a Service Oriented Architecture**

## **Why it's Different**



# **A Strategy for Managing Development and Certification of Net-Centric Services within the Global Information Grid**

---

**Bernal Allen  
DISA, GE 4  
25 Oct 2005**



# Strategic Planning Guidance

---

- “(U) Developing Command and Control to Exploit the GIG. The Department must develop a **unified command and control capability** that can fuse available information and allow decision makers at **all levels to act on this information**. To help accomplish this, Components will fund the GCCS Family of Systems programs to deliver C2 capabilities specified in their respective requirements documents. Components will plan to **transition GCCS to a joint, net-centric C2 capability**.”

Task # 21: “(U) Transition GCCS to joint, net-centric capability.”

**C4 Transformation:  
From System-centric  
to Web Service-centric  
Why Change?**



# Today's C4 is system-centric

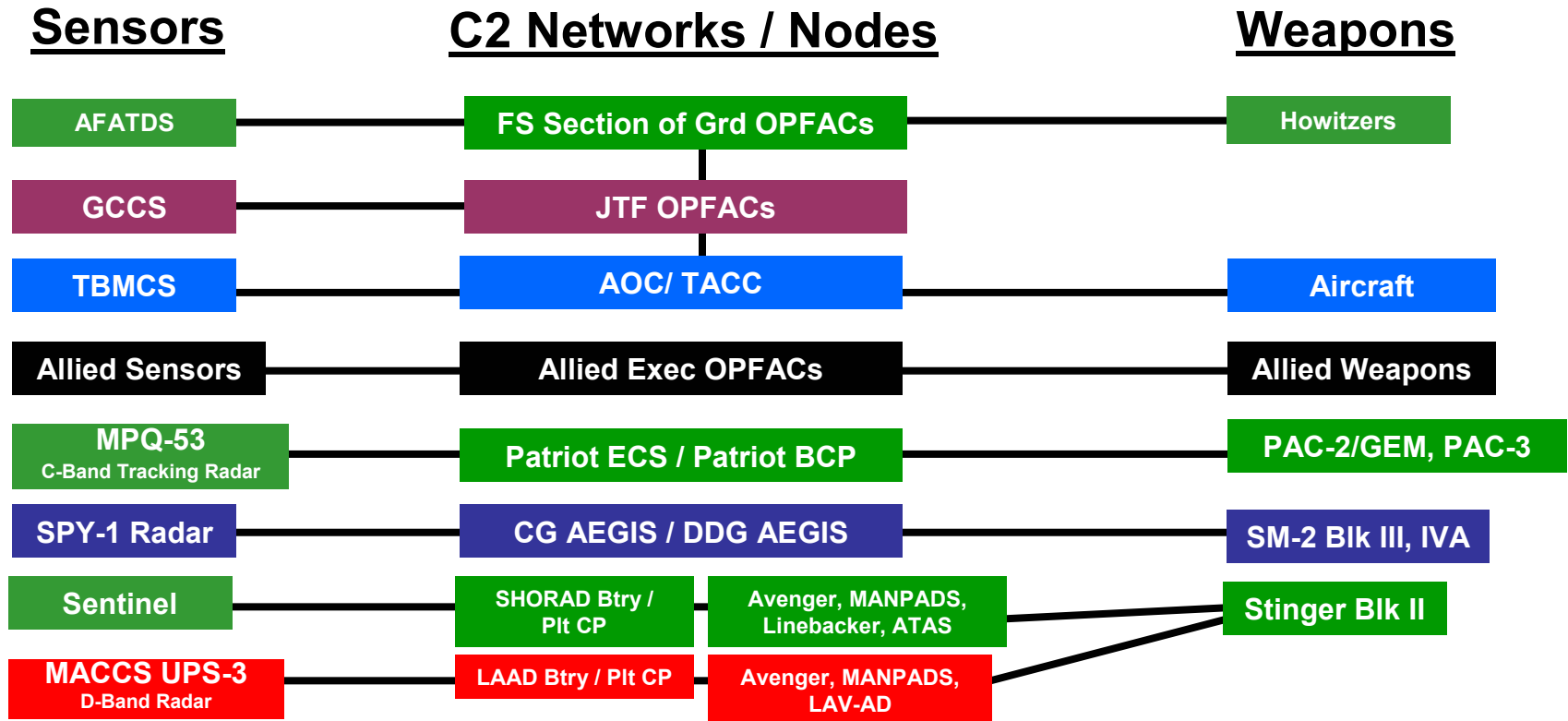

**AFATDS** – Army Field Artillery Tactical Data System  
**TBMCS** – Theater Battle Management Core System  
**GCCS** – Global Command and Control System  
**CG / DDG** – Guided Missile Cruiser / Guided Missile Destroyer  
**LAAD** – Low Altitude Air Defense

**LAV-AD** – Light Armored Vehicle Air Defense  
**MACCS** – Marine Air Command and Control System  
**SM-2** – Land Attack Standard Missile  
**THAAD** – Terminal High-Altitude Area Defense

**Information is bound to multiple system of systems**

# GCCS-J maintains more than 90 system Interfaces

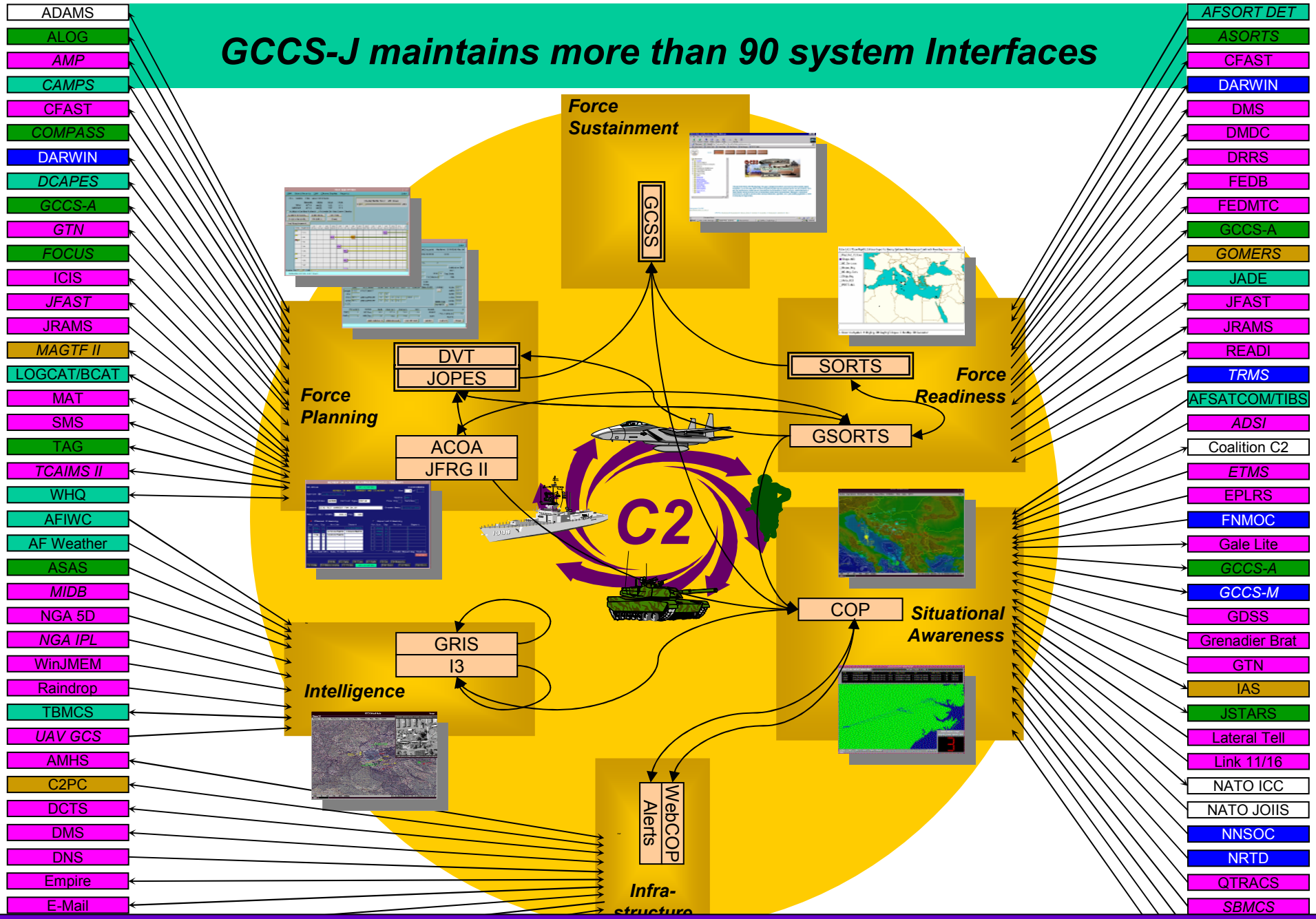

**Maintaining system of systems technical interfaces**



# GCCS-J has 23 Executive Agents

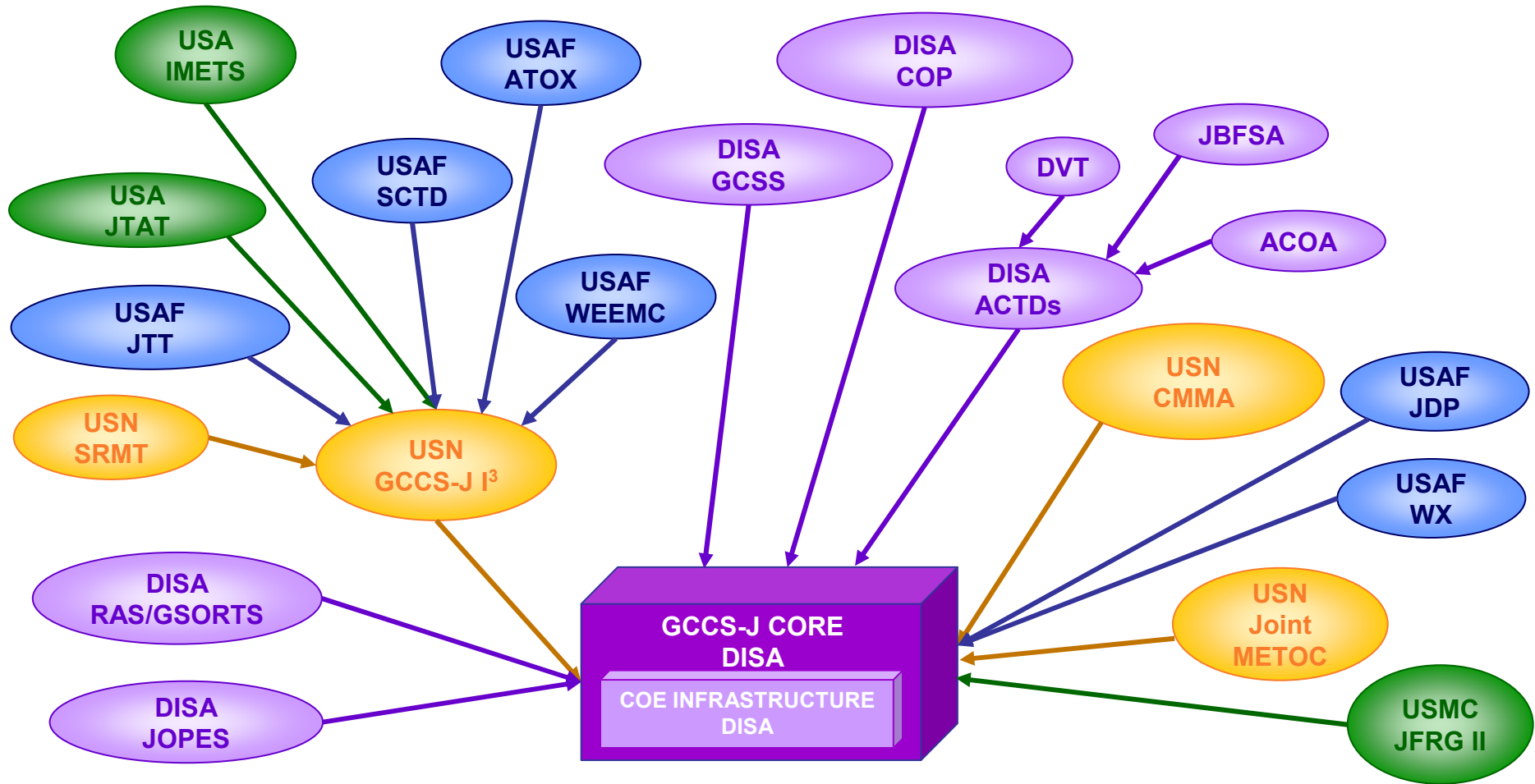

**Maintaining system of systems program baseline synchronization**



# Joint Mission Threads are derived from C2 Systems of Systems

## Proposed JBMC2 JMT Assessment Schedule

Joint Mission Threads	2005	2006	2007	2008	2009	2010	2011	2012	2013
Joint Close Air Support									
Joint Task Force Command & Control (JTFC2)									
Integrated Air / Missile Defense (IADM)									
Time Sensitive Targeting (TST)									
Joint Ground Maneuver (JGM)									
Integrated Fires (IF)									
Focused Logistics (FL)									

Yesterday's system-based techniques and technologies are too brittle to meet today's demands for cross system integration

**System of System integration is a long and complex process**





# A Service-centric Architecture

## Service Oriented Architecture (SOA)

A set of principles that together define an architecture that is **loosely coupled** and **comprised of service providers and service consumers** that **interact according to a negotiated contract or interface**.

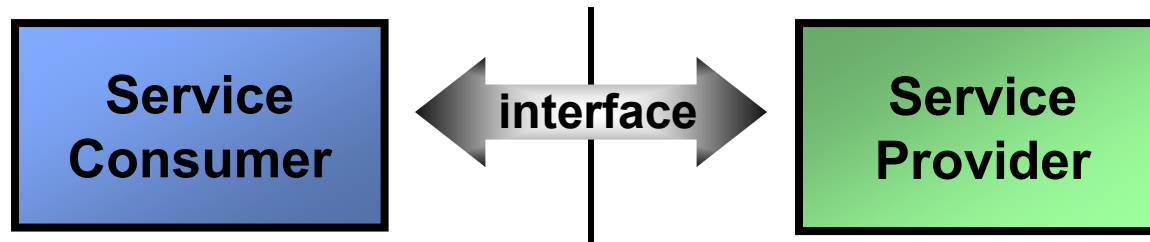

- Can search and find a Service
- Has a need or want that determines context of use
- Not concerned with how service is developed only how it is provided

- Can be found in a registry
- Fulfills a need or want
- Abstracts the details of production
- Can be upgraded or replaced transparently



# Service Oriented Architecture Provides Composable Services *for Just-in-time Capabilities!*

Higher-Level Service Composed of Lower-Level  
“Fundamental” or “Atomic” Services

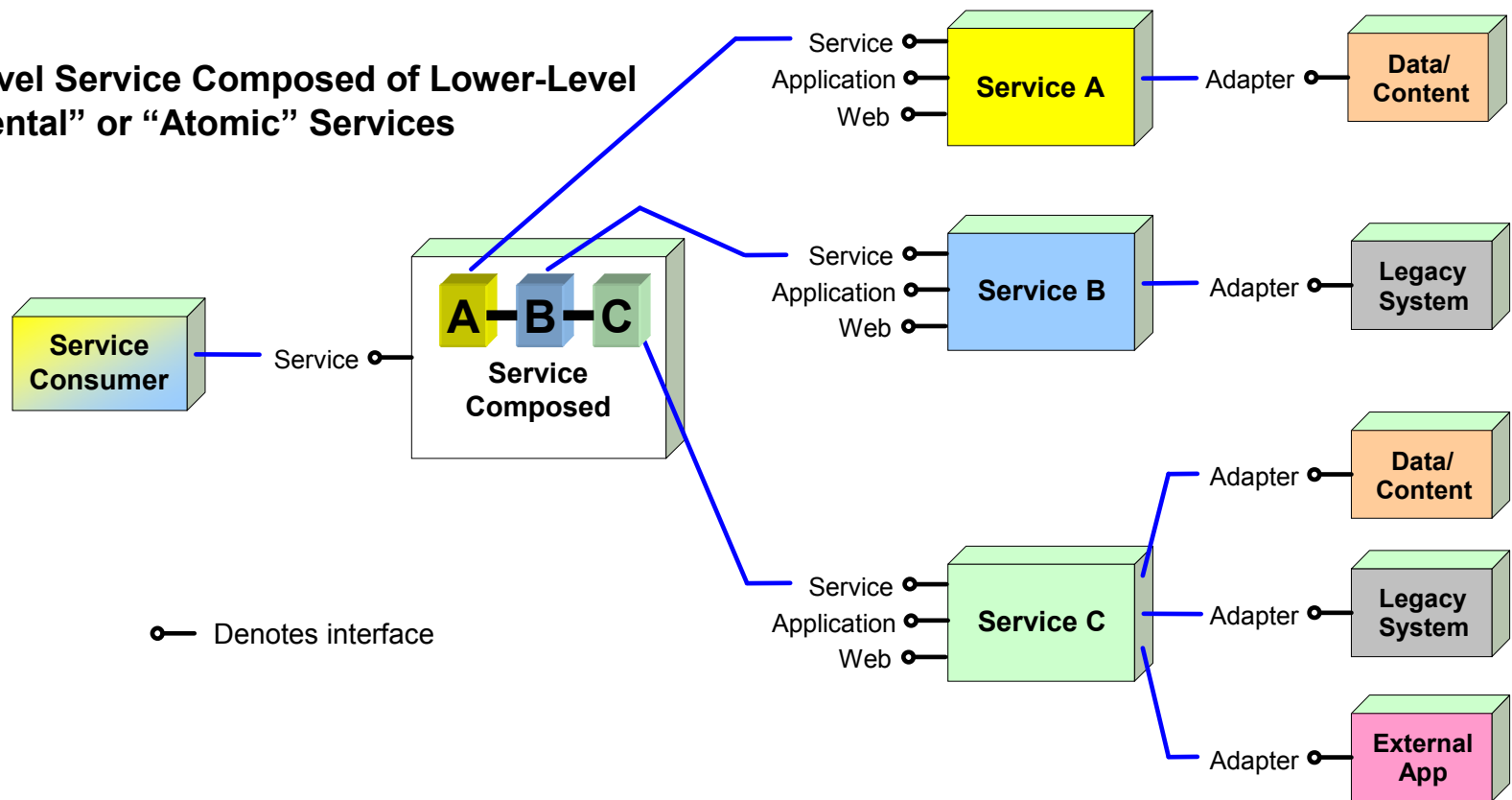



Amazon.com: Welcome - Defense Information Systems Agency

Shop in Jewelry & Watches (Beta-What is this?)

amazon.com

VIEW CART | WISH LIST | YOUR ACCOUNT | HELP

WELCOME YOUR STORE BOOKS APPAREL & ACCESSORIES ELECTRONICS TOYS & GAMES HOME & GARDEN CAMERA & PHOTO SEE MORE STORES

INTERNATIONAL TOP SELLERS TODAY'S DEALS SELL YOUR STUFF

Got a Web site? Join Amazon Associates today and make money! Learn more

SEARCH

All Products

FREE Super Saver Shipping on orders over \$35. Restrictions apply.

POWERED BY GOOGLE

BROWSE

Featured Stores

- Health Care (Beta - What is this?)
- Jewelry & Watches (Beta - What is this?)

Hello. Sign in to get personalized recommendations. New customer? Start here.

Presidential Candidates

Use Amazon 1-Click to make a contribution. Easiest way to make small contributions from \$5 to \$200.

What's Hot in Cookware

Brown, sear, and cook the way you want with Calphalon One Infused Anodized cookware.

Get the Amazon.com Visa® Card Instantly!

Get your card instantly and Save \$30 today!

Find out how

amazon.com PLATINUM

4417 1234 5678

02/01/08 02/01/08

amazon.com

WHAT'S NEW

Already a customer? Sign in to see what's New for You.

New Releases

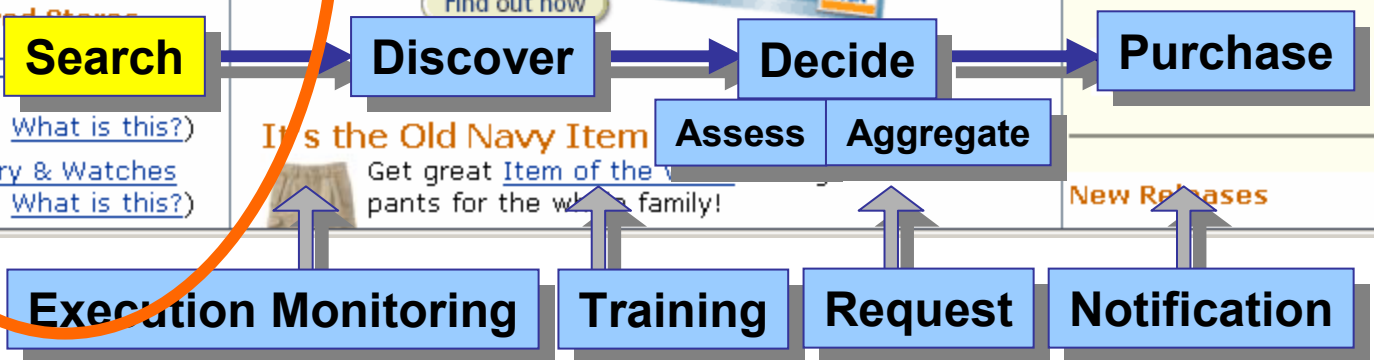
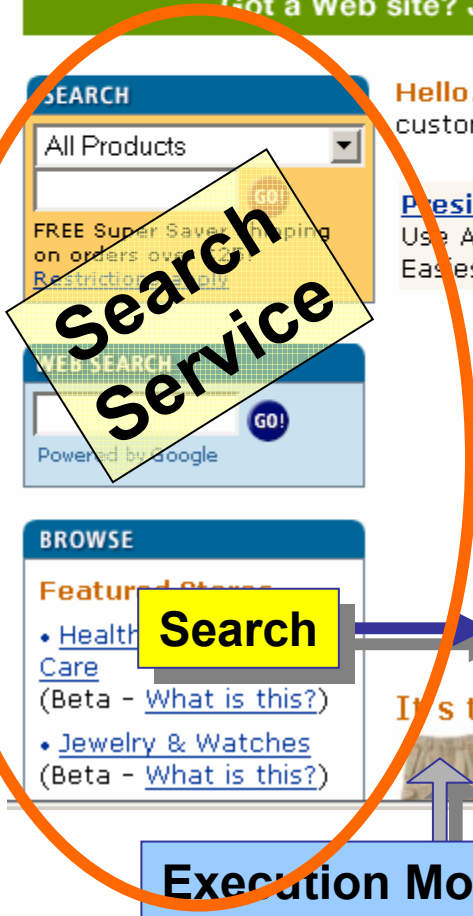



# Air / Space Operations work flows

**The Warfighter Owns and Shapes The Process**

**Metrics: Auto operations & combat assessment**

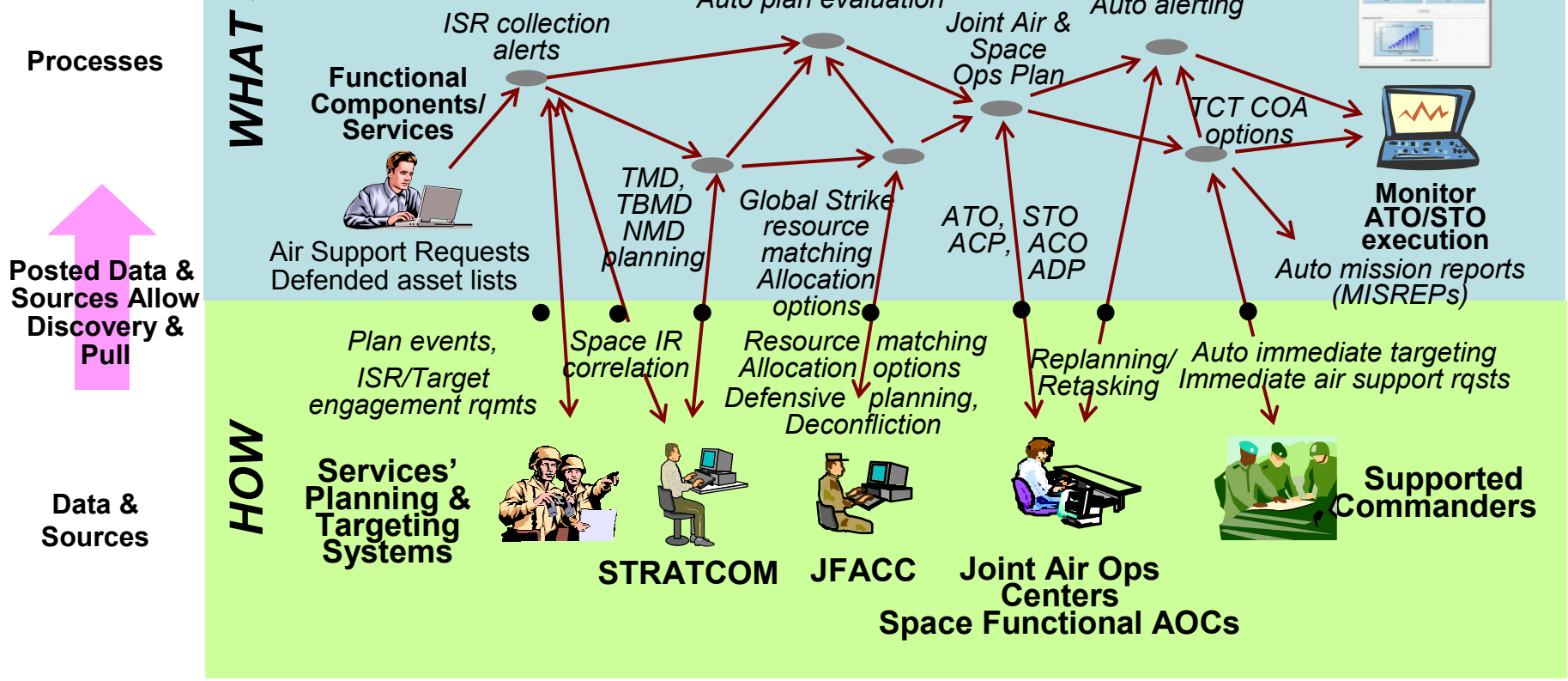

**Data Centric & Process Oriented: Information flows across multiple, OPFACs, platforms, and sensors**



# Task: Global Strike Mission Planning

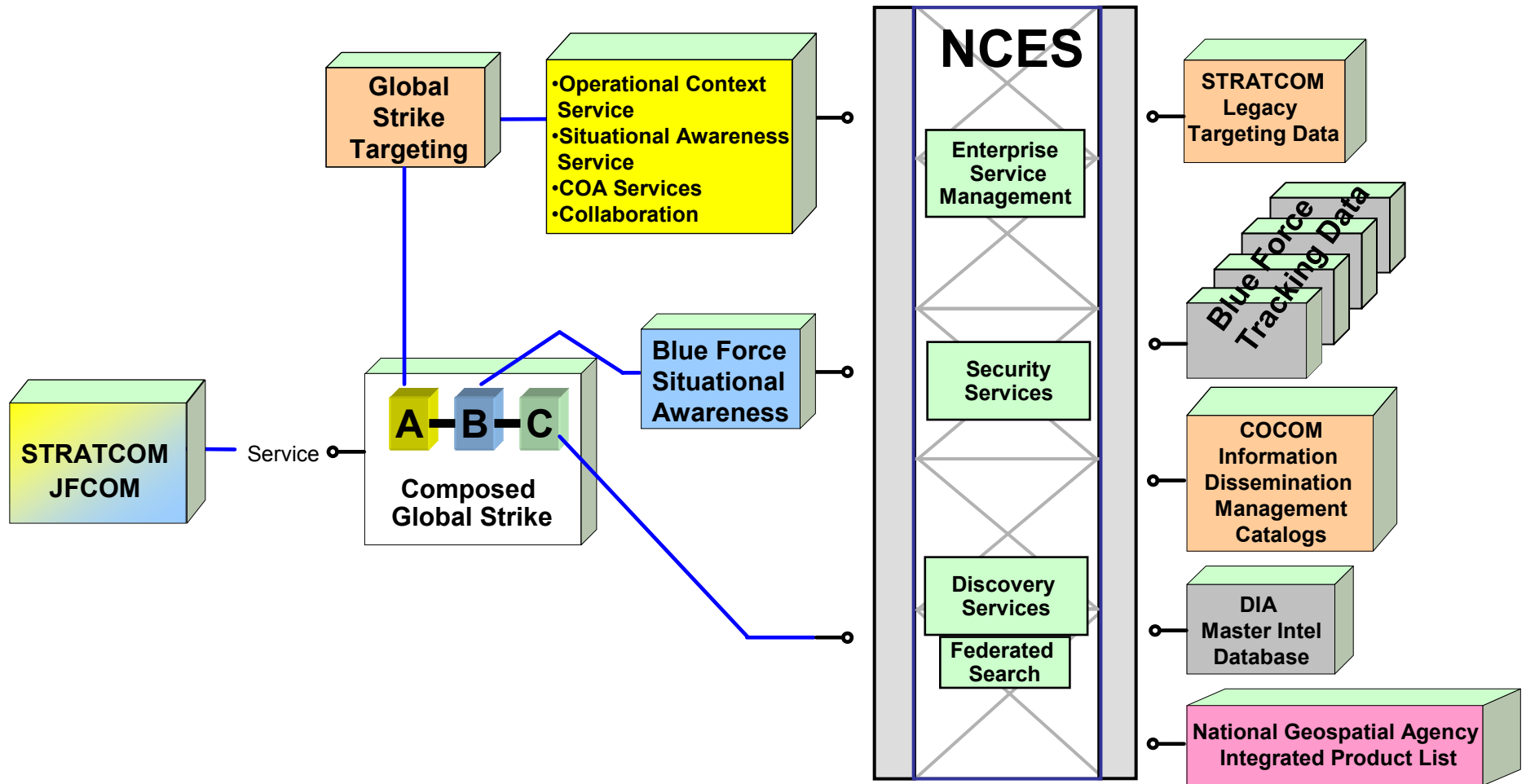

NCCP Oktoberfest 2004

—○ Denotes interface



# Task: Global Strike Mission Planning

CoMotion Web Interface - Microsoft Internet Explorer

File Edit View Favorites Tools Help

Address  Go Links >>

Shared Works

- .LIBRARY
- Red Thunder W
- Red Thunder W
- SR EXSUM

Private Works

- vecchiog

Tools

- View Tools
- Geospat
- Timeline
- Status V
- Item De
- Image V
- Text Vie
- Hierarch

New Items P

- Context It
- Folder
- Workspa
- Asset

Exec Summary - COA DEVELOPMENT TEMPLATE

Miss. State. CDR's Intent C2 Timeline Other Guidance COAs

COA Matrix	Wt	1 B-2	1 B-52: 12xAGM	1 B-52: 8xAGM	COAs
Rank >		1	1	1	
a. Type		Stealth	Heavy Bomber	Cruise Missile	
b. All Weather		Y	Y	Y	
c. Civilians At Risk		MEDIUM	MEDIUM	MEDIUM	
d. Collateral Damage		VERY LOW	VERY LOW	VERY LOW	
e. Defense Suppression		4	4	0	
f. Personnel At Risk		10	25	11	
g. Force Package		MEDIUM	MEDIUM	MEDIUM	
h. Minimum Time		17	28	23	
i. Potential Loses		1	1	0	
j. Total Weapons		10	7	6	
k. Recover Notes		6-12 months	6-12 months	6-12 months	
<b>Total</b>					

NCCP Oktoberfest 2004

powered

Applet gov/cinc21/dfc2/comotion/applet/DFC2Applet started

Internet

# **C4 Capability Development with Service Oriented Architectures**

## **How it's Different**



# Taking a Chapter from the Commercial World

## eBay.com



- **WWW-based E-Commerce Leader \***
  - \$8 Billion quarterly sales
  - 1.7 Billion dynamic content page views per day
  - 50 million active traders / user
  - Localized to 27 countries
- **eBay Infrastructure \***
  - 25 million items listed at any given time
  - Over 2,000 application servers
  - Over 100 Oracle database
  - 3+ Terabytes of storage
- **KEY POINT:**
  - 40% of all business transactions conducted via eBay's Web Service Platform \*

\* Source: "Web Service in Action: Integrating with the eBay Marketplace", O'Reilly, June 2004





# eBay's Core Entities ( a very terse architecture!)

## Item

sellable on eBay.

**All of eBay's Web Service methods  
revolve around these entities**

## Listing

(noun) An entry on eBay with one or more items; (verb) The action of creating such a listing. An auction is a type of listing that enables competitive bidding.

## Categories

A hierarchical set of groups on eBay in which items of a similar nature are listed.

## User

Someone who has registered with eBay. There are user roles such as bidder, buyer, seller, store owner and application developer.

## Transaction

The data for the purchase of one or more items by one buyer from one listing. Some listings enable a seller to offer multiple items in the same listing; thus there could be multiple buyers purchasing items from the same listing and therefore multiple transactions for the same listing.

## Feedback

An eBay mechanism or system by which one user may rate another user, enabling other users to know how well or how poorly a transaction went.



# All eBay Web Service are available for Partner Developers

The screenshot shows a Microsoft Internet Explorer browser window displaying the eBay Developers Program documentation. The address bar shows the URL: [http://developer.ebay.com/DevZone/docs/API\\_Doc/index.asp](http://developer.ebay.com/DevZone/docs/API_Doc/index.asp). The page title is "API Technical Documentation - Microsoft Internet Explorer". The main content area is titled "GetAllBidders Function Logic" and contains the following text:

Call **GetAllBidders** to return a list of all the bidders associated with a listing (whether ended or still open). **GetAllBidders** is primarily used as part of the **Second Chance Offer** feature. From the list of bidders returned by **GetAllBidders**, the seller selects one bidder to which the seller will extend a second chance offer for the item. But **GetAllBidders** can also be used to retrieve the bidders for non-Second Chance Offer listings.

[Calling GetAllBidders](#)  
[Working with the GetAllBidders Result Set](#)

### Calling GetAllBidders

In a call to **AddSecondChanceItem**, the value passed in the **RequestToken** argument identifies the user making the function call (typically the item's seller).

When determining the list of bidders from which to make a second chance offer for the listing:

1. Pass the item ID for the ended listing to be offered as a second chance purchase in the **ItemId** input argument.
2. Pass a value of true (1) in the **SecondChanceEnabledOnly** argument.
3. Pass a value of false (0) in the **ViewAllBidders** argument (or omit the tag altogether from the request).

The bidders returned are the eBay users that submitted bids on that item (who were not a winning bidder) and who agreed to accept second chance offers.

When retrieving a list of a listing's bidders other than for the purpose of making a second chance offer:

1. Pass the item ID for the listing in the **ItemId** input argument. (May be an ended listing or a still-active listing.)
2. Pass a value of true (1) in the **ViewAllBidders** argument.
3. Pass a value of false (0) in the **SecondChanceEnabledOnly** argument (or omit the tag altogether from the request).

The bidders returned by such a call are the eBay users who have placed bids on the listing specified in **ItemId**.

The table below shows the combinations in which the **SecondChanceEnabledOnly** and **ViewAllBidders** arguments may and may not be used together.

SecondChanceEnabledOnly	ViewAllBidders	Effect
1	0	Returns all non-winning bidders for an ended listing who agreed to accept second chance offers.
0	1	Returns all bidders for an ended or still-active listing.
0	0	Returns all non-winning bidders for an ended listing.
1	1	Not permitted. Will result in an error.

For a call to **GetAllBidders** to be successful, the following conditions must be met:

Technical on-line documentation available for all EBay web services, including sample code on how to use them in an contextual example



# eBay's Development/Production Environment

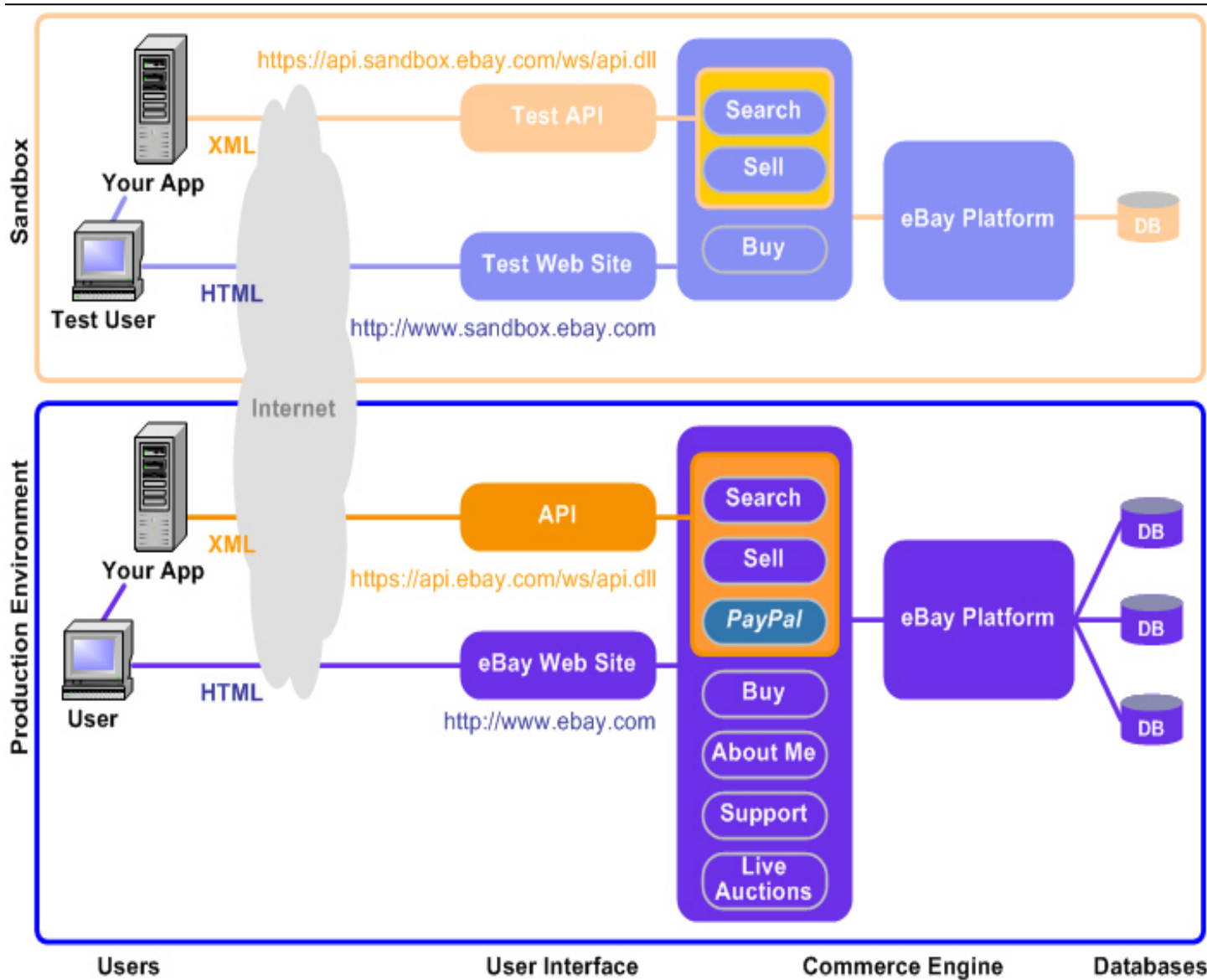

A web accessible development environment available to all partners



# eBay's Development Environment & Support

---

- **Key Elements for Take Away:**
  - **Simple and understandable architecture**
    - **Seven nouns and verbs**
  - **Development Web Site (<http://developer.ebay.com>)**
    - **Extensive documentation available on web service**
      - **API Specifications, Code Samples, How-to-docs**
    - **Software Development Kit (SDK) available**
      - **.NET, JAVA, and other programming language support**
    - **Forums and Technical Support available on-line**
  - **Development Sandbox**
    - **Area to test applications against sample data sets**
    - **Area to field new eBay APIs and conduct alpha testing**
    - **Certificate process to validate user access**
    - **Process in place to help developers determine simple functionality and performance characteristics**
    - **Module certification program to provide some assurance before developer roles capability into production**

**eBay started with a federated development mindset!**



# “The Strategy”

- **Establish a Federated Development & Certification Environment (FDCE) as a distributed and collaborative environment addressing the challenges associated with concurrent and distributed Service Management.**
- **Its purpose is to establish the**
  - **Infrastructure, Processes, and Policies**
- **so that Services can be progressively**
  - **Developed, Tested, Refined, and Certified**
- **with increasing rigor leading to operational deployment.**

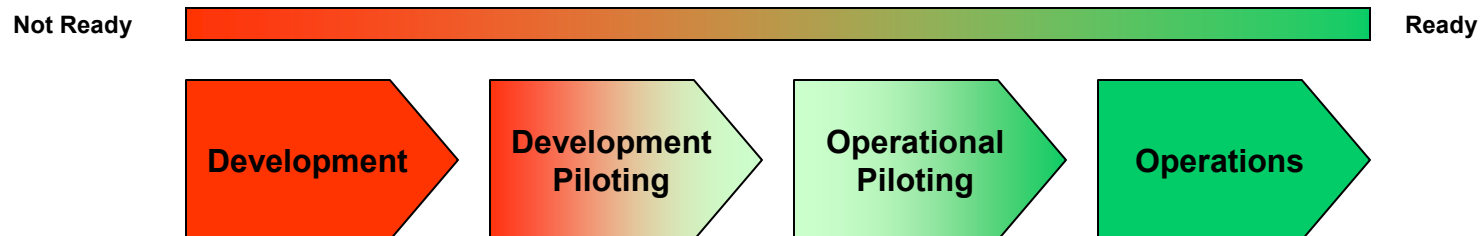



# Proposed JC2 Federated Development and Certification

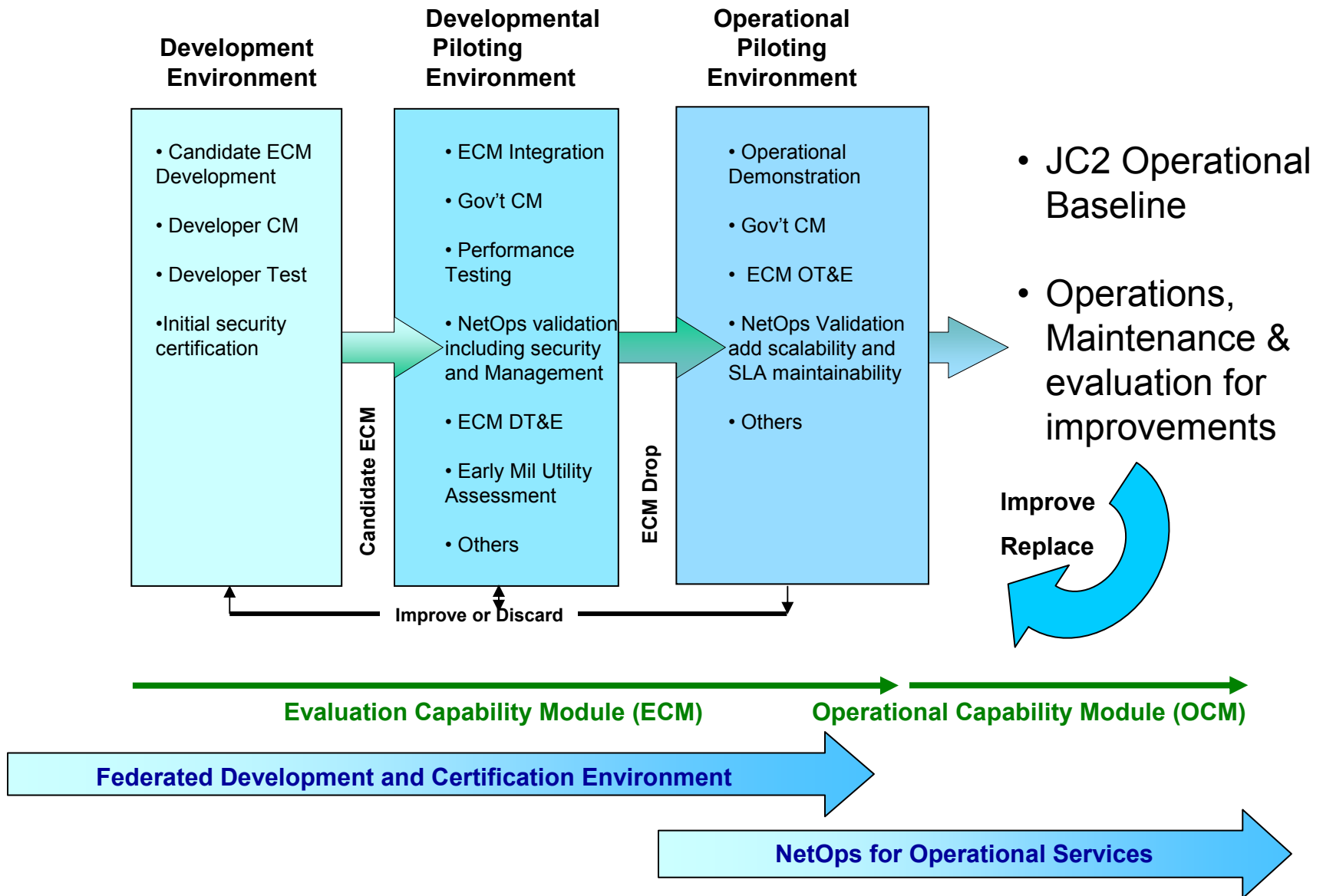



# Notional Certification Requirements

	Development Tier	Development Piloting Tier	Operational Piloting Tier	Operational Tier
Registration	Yes	Yes	Yes	Yes
Security	No	Yes	Yes	Yes
Configuration Mgt	No	Yes	Yes	Yes
ESM Enabled	No	Yes	Yes	Yes
Availability Guarantees	No	No	Yes	Yes
Response Time Guarantees	No	No	Yes	Yes
Reliability/Surv Guarantees	No	No	Yes	Yes
NETOPS Ready	No	No	Yes	Yes
On-Line Help	No	No	Yes	Yes
Life Cycle Commitments	No	No	No	Yes



# FDCE pilot as part of FY04-05 NCCP initiative

- <http://fdce.net>
- 57 participants representing all Components
- 34 web services registered and undergoing initial certification

\* As of 12 Aug 05





# **Cultural Change And Next Steps**



# SOA Evolution: Think Differently

---

**Becoming Net-Centric means ....**

Participating as a part of a **continuously evolving ecosystem** of people, devices, information and services; interconnected by a communications network **to achieve optimal benefit of resources and better synchronization of events and their consequences.**

**This is about Culture Change...**



# What we are learning ...

COI Services will be derived from multiple heterogeneous capabilities. Issue: program synchronization

Test, cert and accreditation needs to be focused on small modules of capability. Issue: loss of E2E perspective

Workflows can be very dynamically composed. issue: JMT may be only locally authoritative

Edge User

Service

**A-B-C**  
Composed Global Strike

Blue Force Situational Awareness

edge users QoS may be dynamically Prioritized. Issue: NetOps

•Operational Context Service  
•Situational Awareness Service  
•COA Services

