

# **Design, Construction and Seepage at Prado Dam**

---

**Douglas E. Chitwood, P.E., G.E.  
Embankment Engineer, Prado Dam**





# SANTA ANA RIVER MAINSTEM PROJECT PROJECT MAP



SAR Mainstem



# Prado Dam

*(after  
Modifications)*

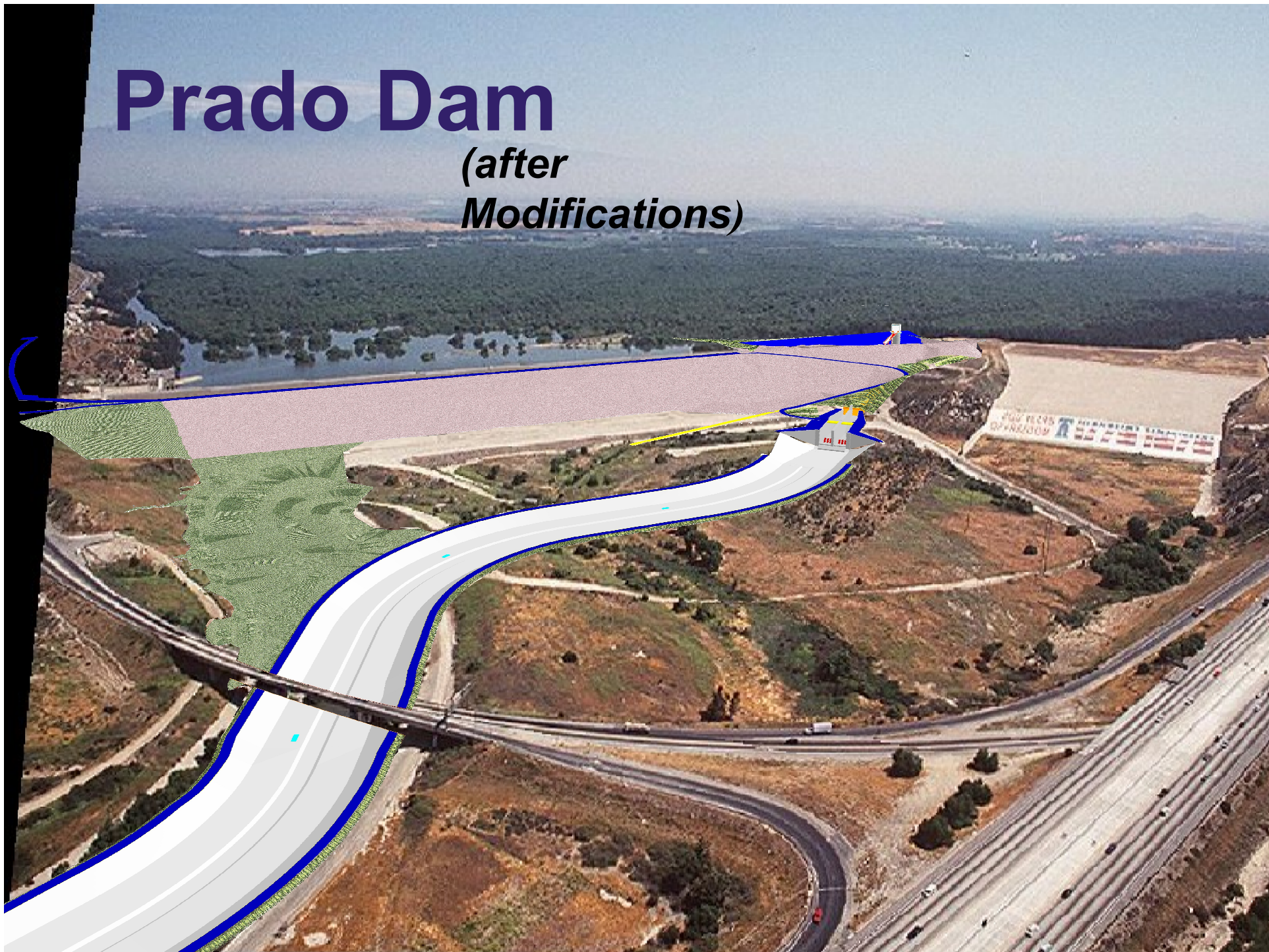



# Prado Dam: Planned Modifications to the Embankment

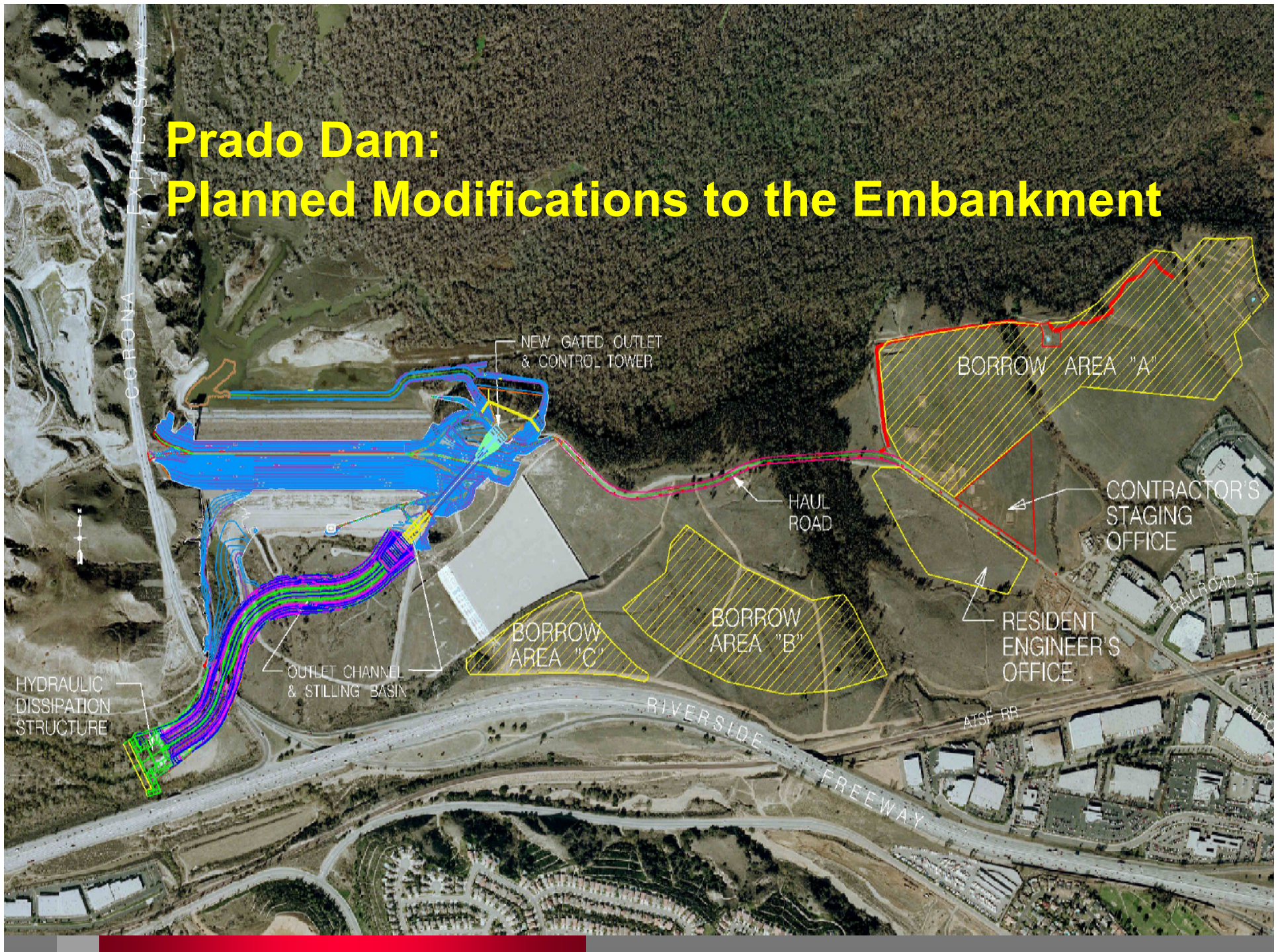



# Original Embankment: Typical Section

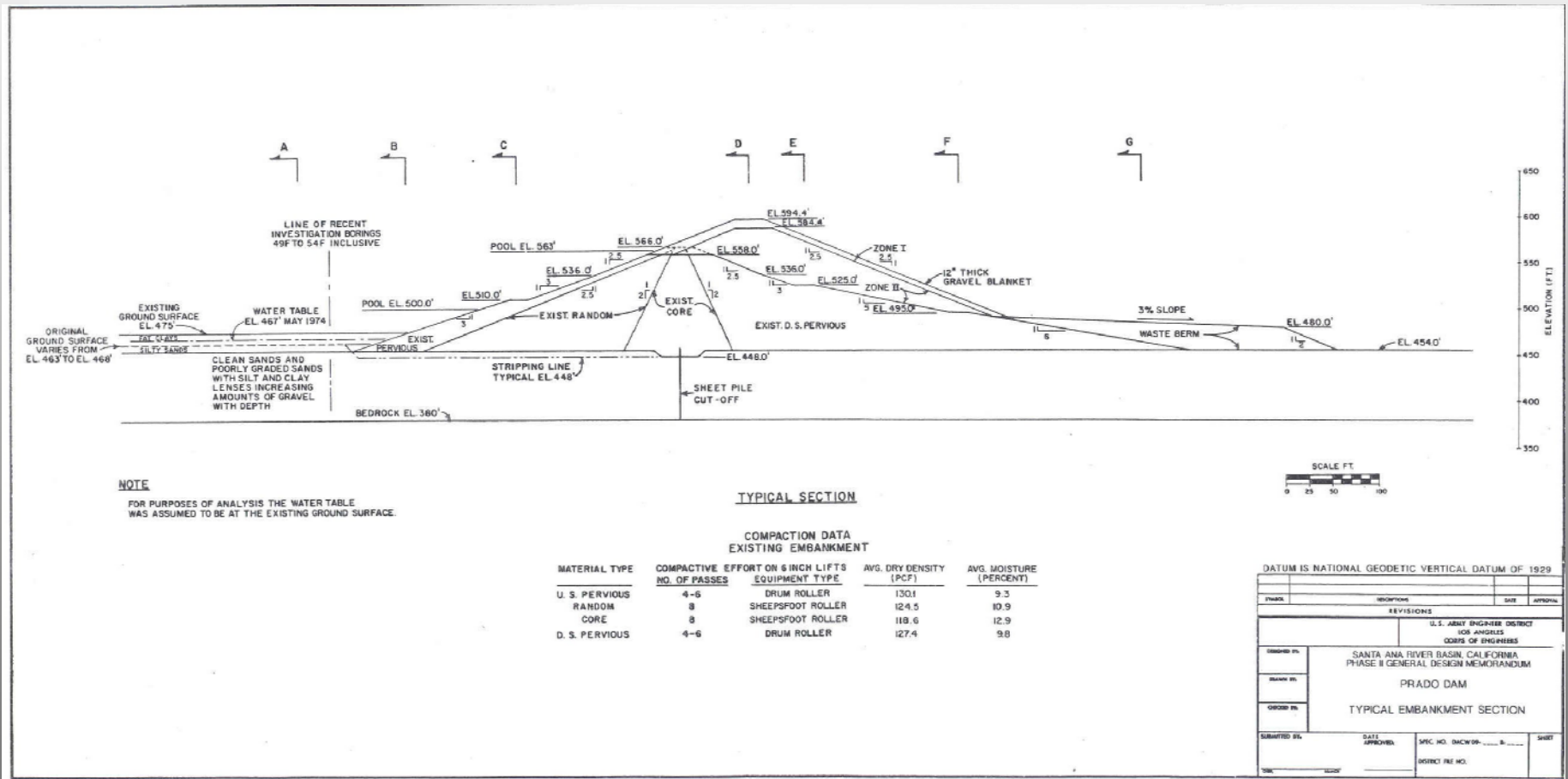

# Typical Dam Section

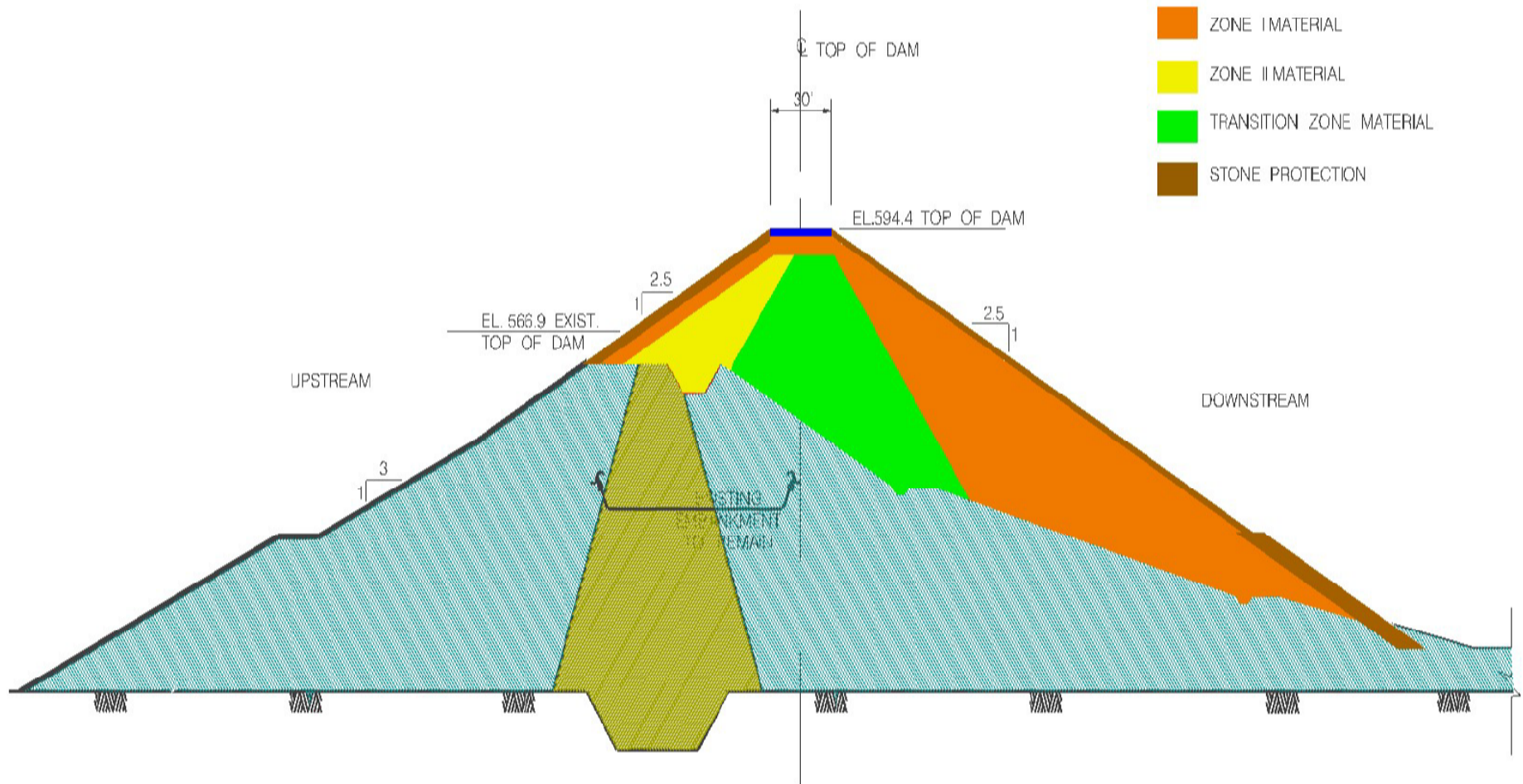







# Zoned Embankment











2004 5 24





2004 12 17



# Prado Dam: New Outlet Channel

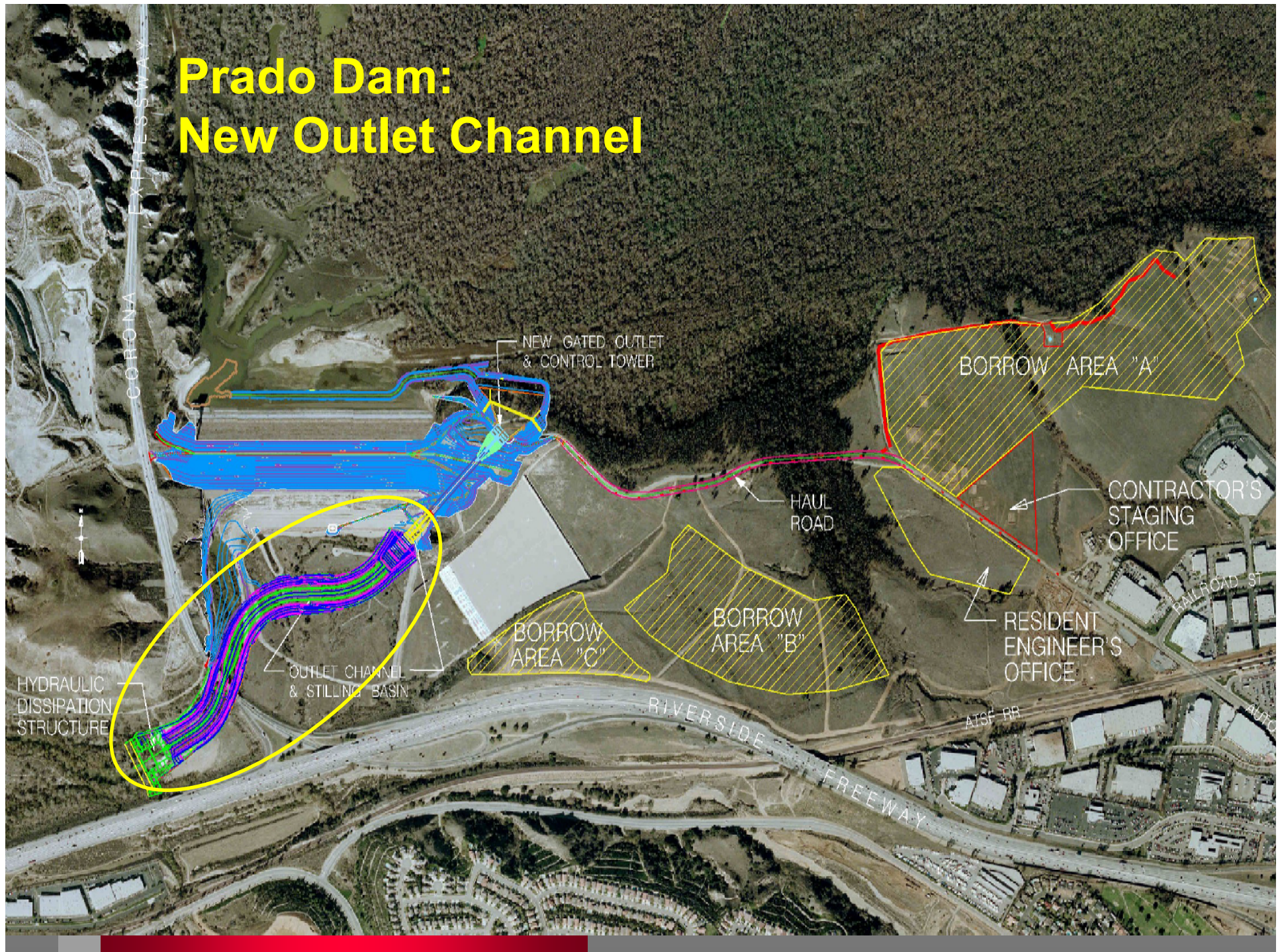



# Outlet Channel Plan

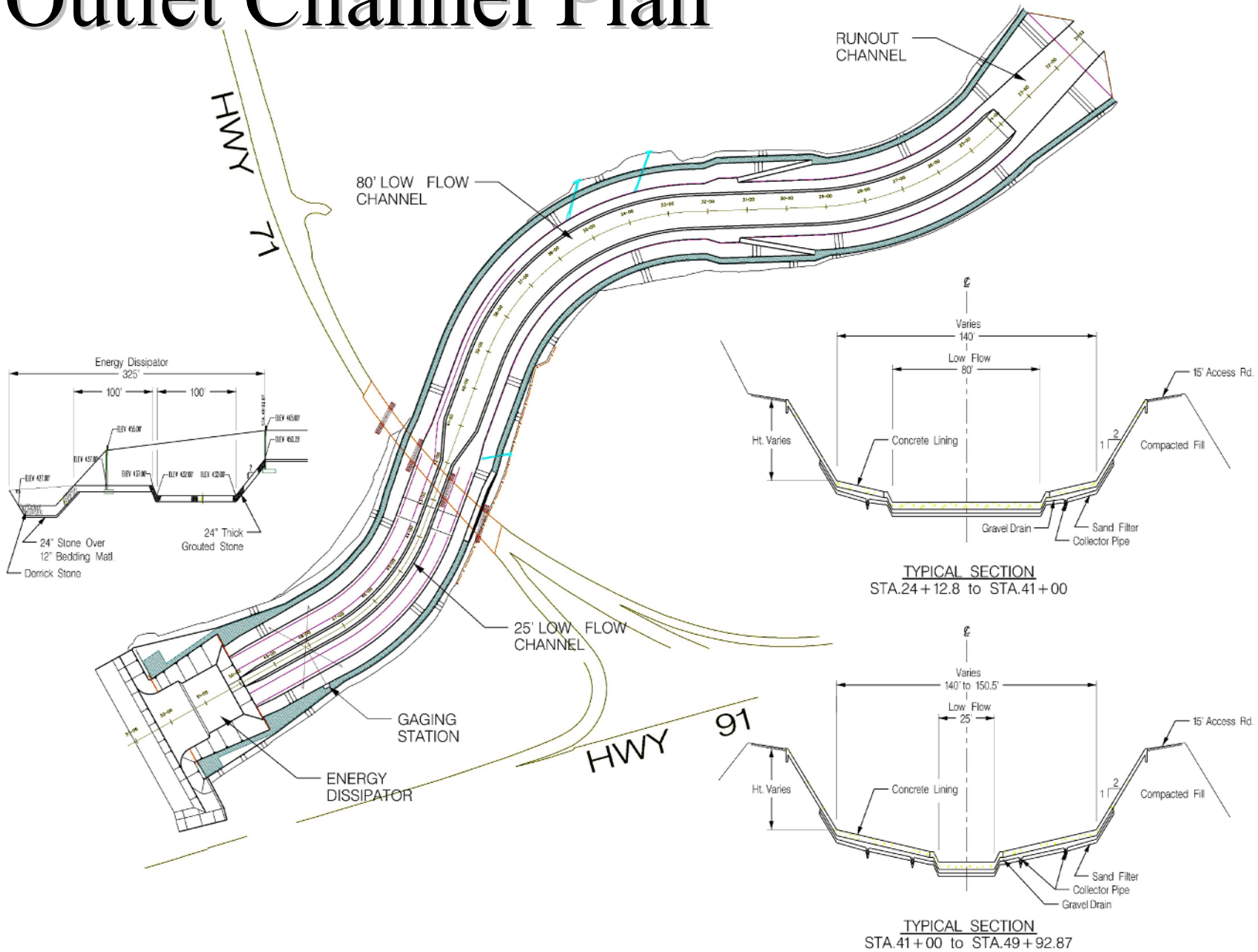







2004 8 18



AUG 23 2004





25  
5:5





25 10:44 AM



2005 4 28







# Prado Dam: Staged Construction of Tower and Conduit

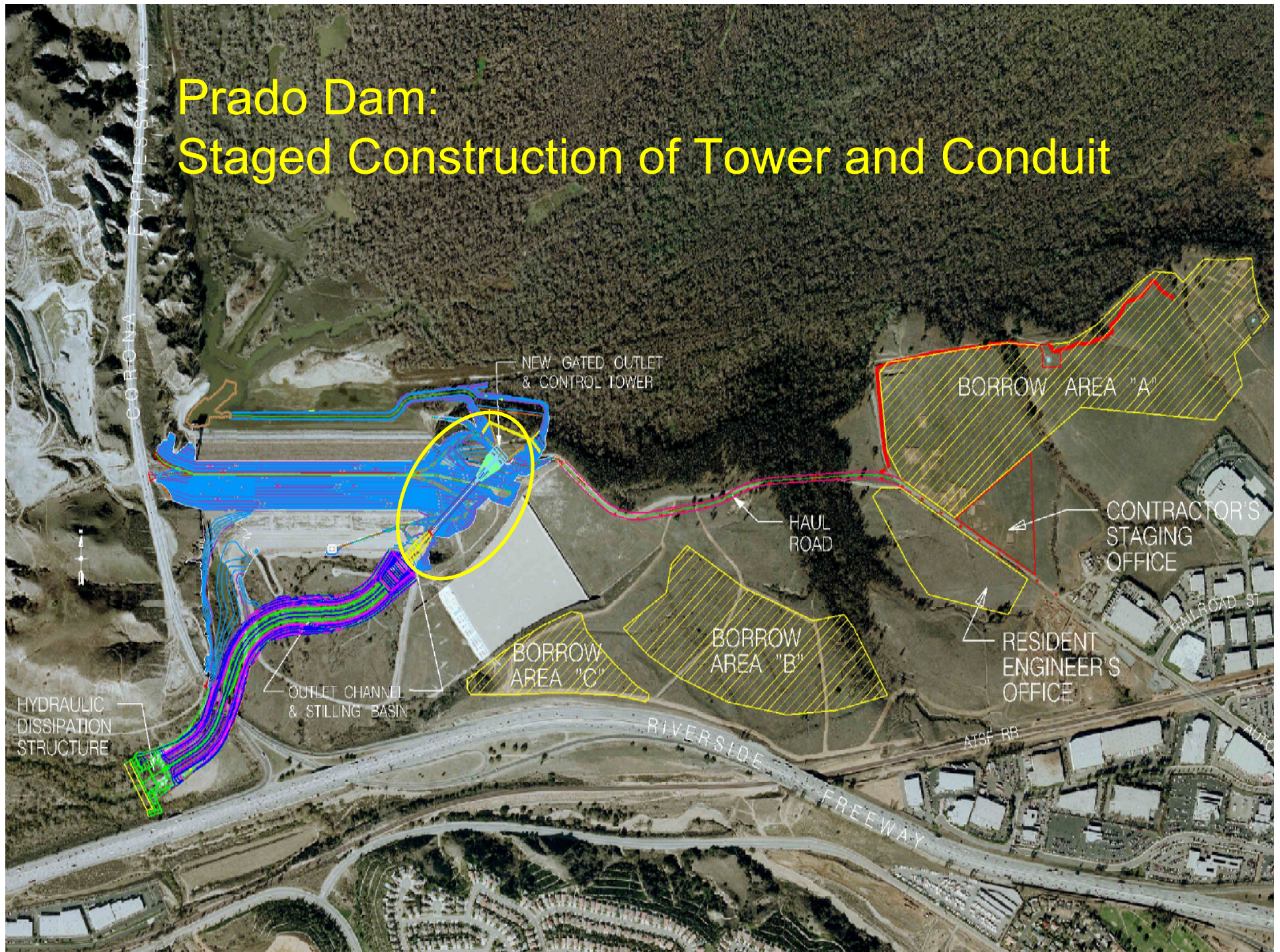



# Design Considerations: Staged Construction

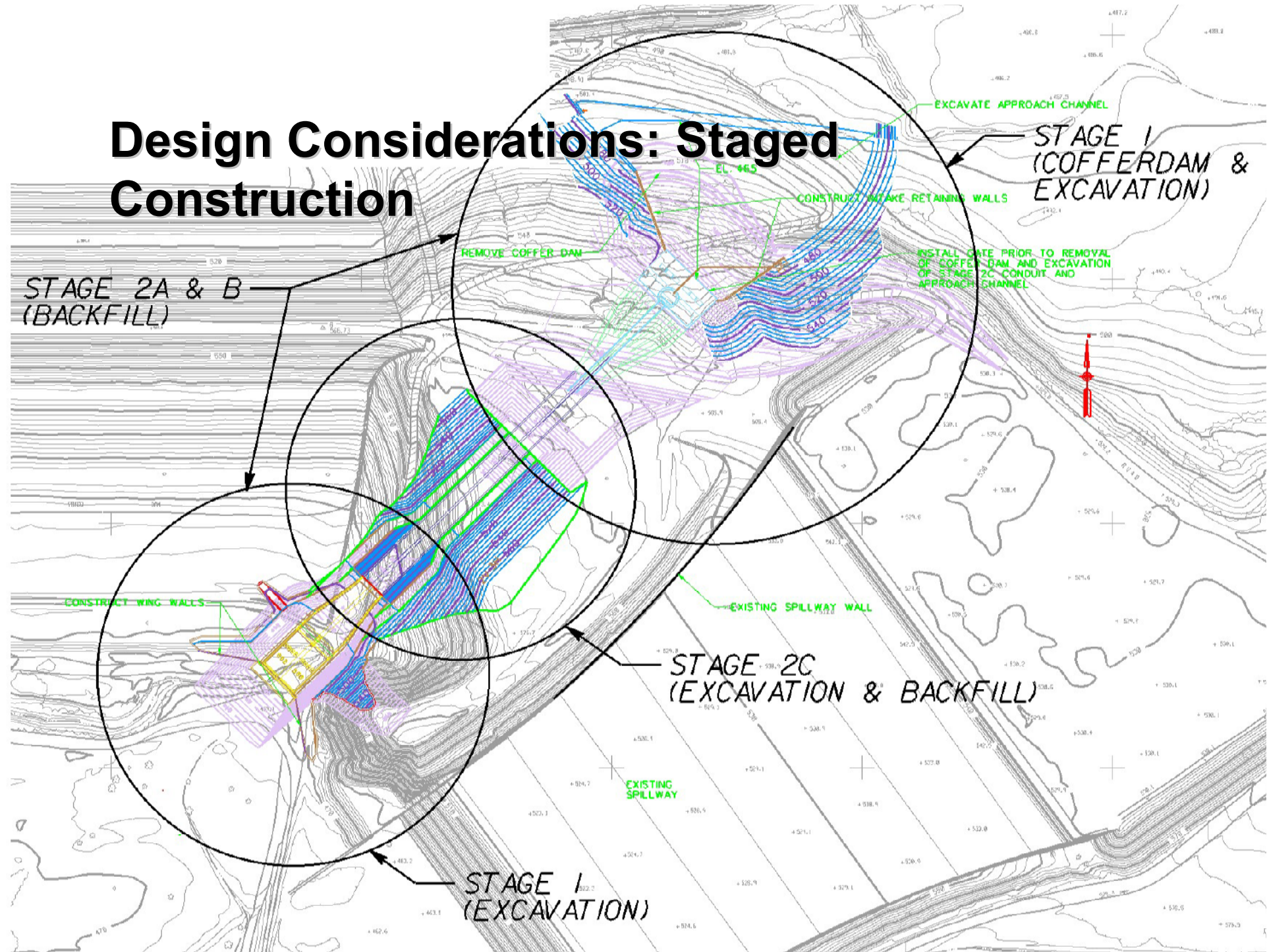

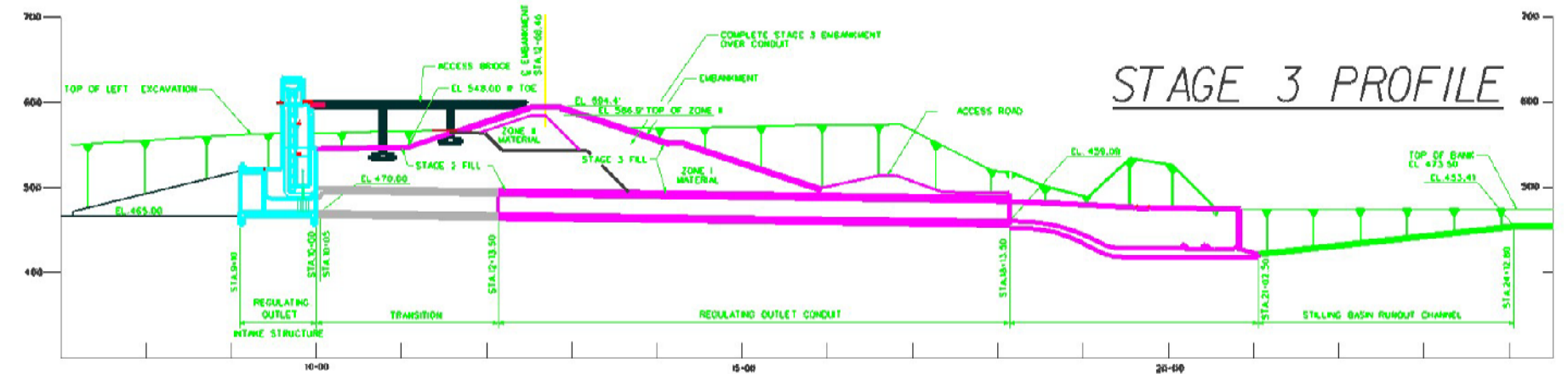
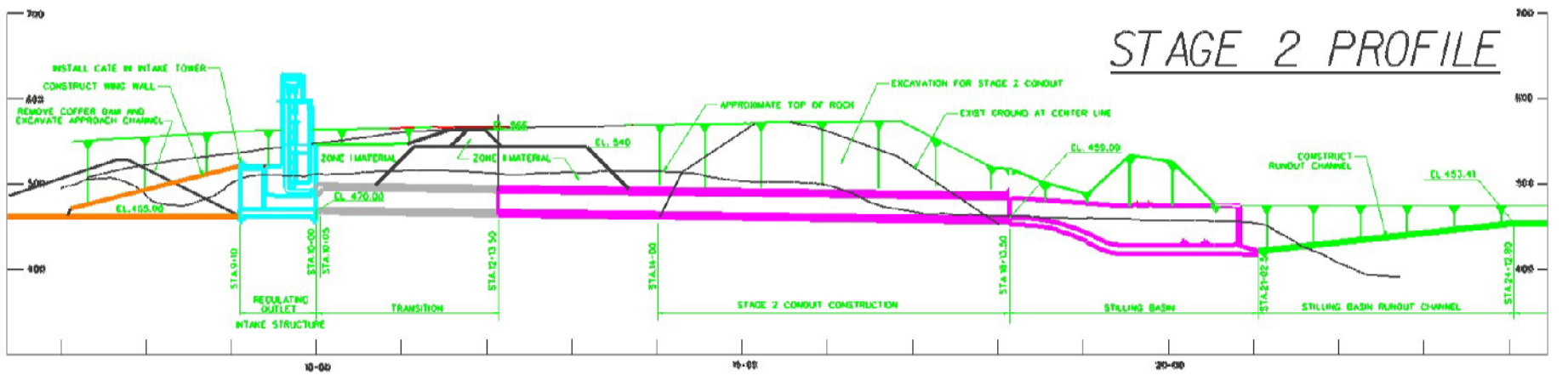
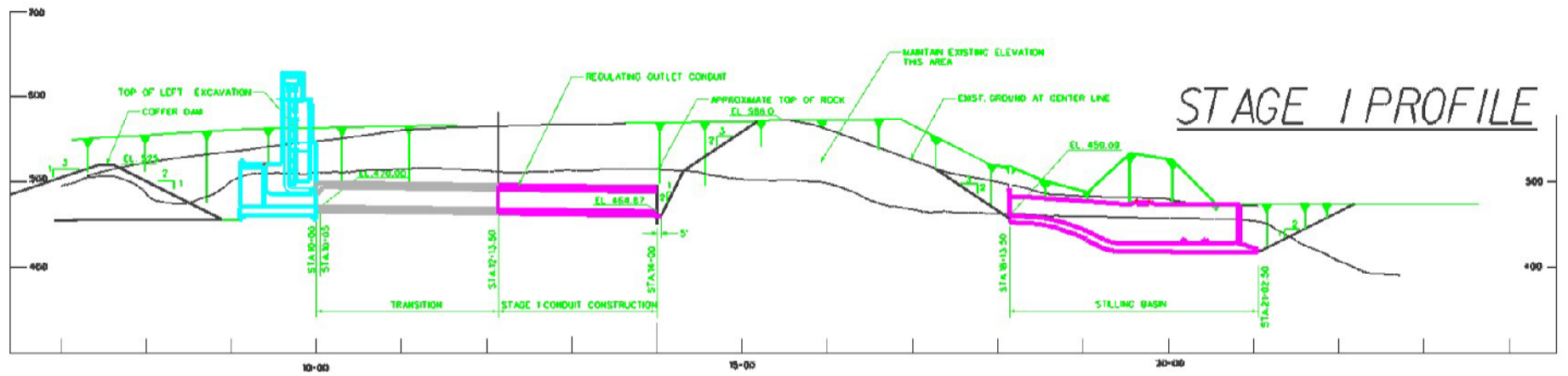



# Stage 1 – Grading Plan

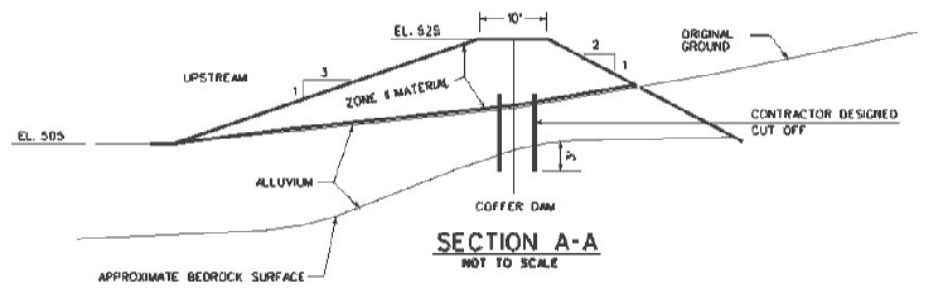
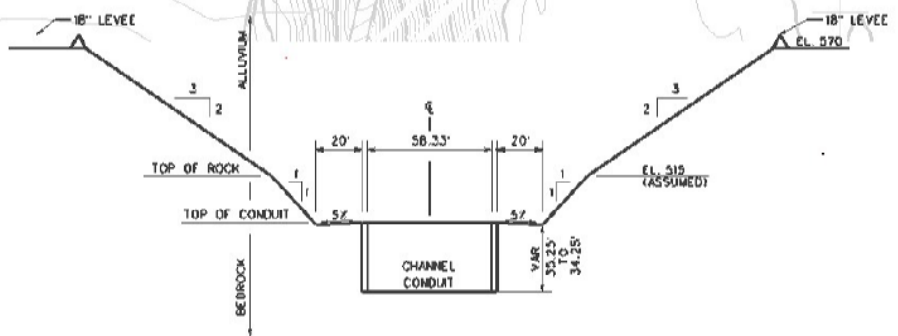
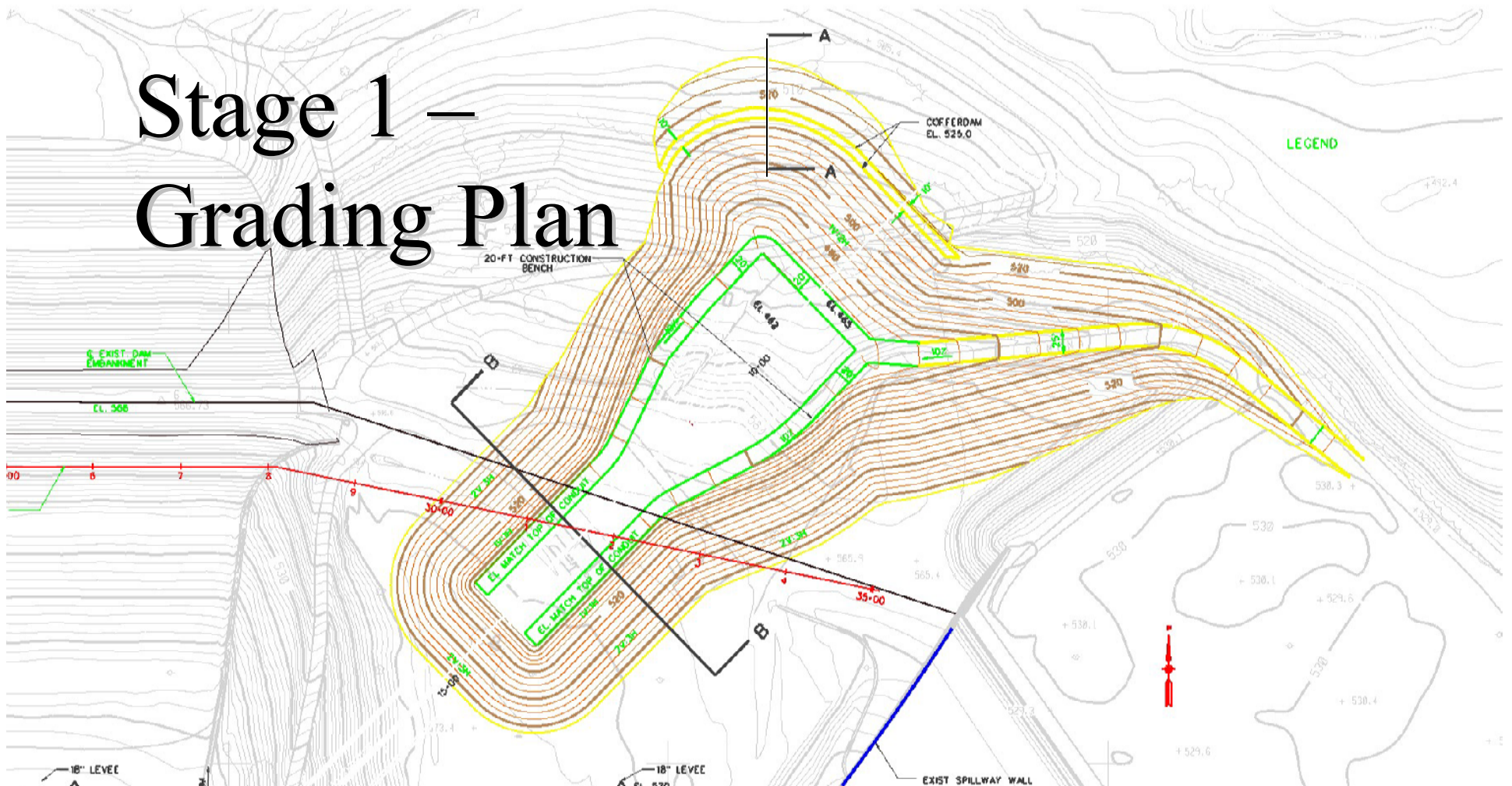

# Stage 1 Excavation





# Stage 1 Excavation





# Cofferdam







Cofferdam 2

Cofferdam 1

2005 2 22





2003 8 5









2003 8 18



# Cofferdam II – Miscellaneous Fill with Visqueen Liner





# Intake/Control Tower

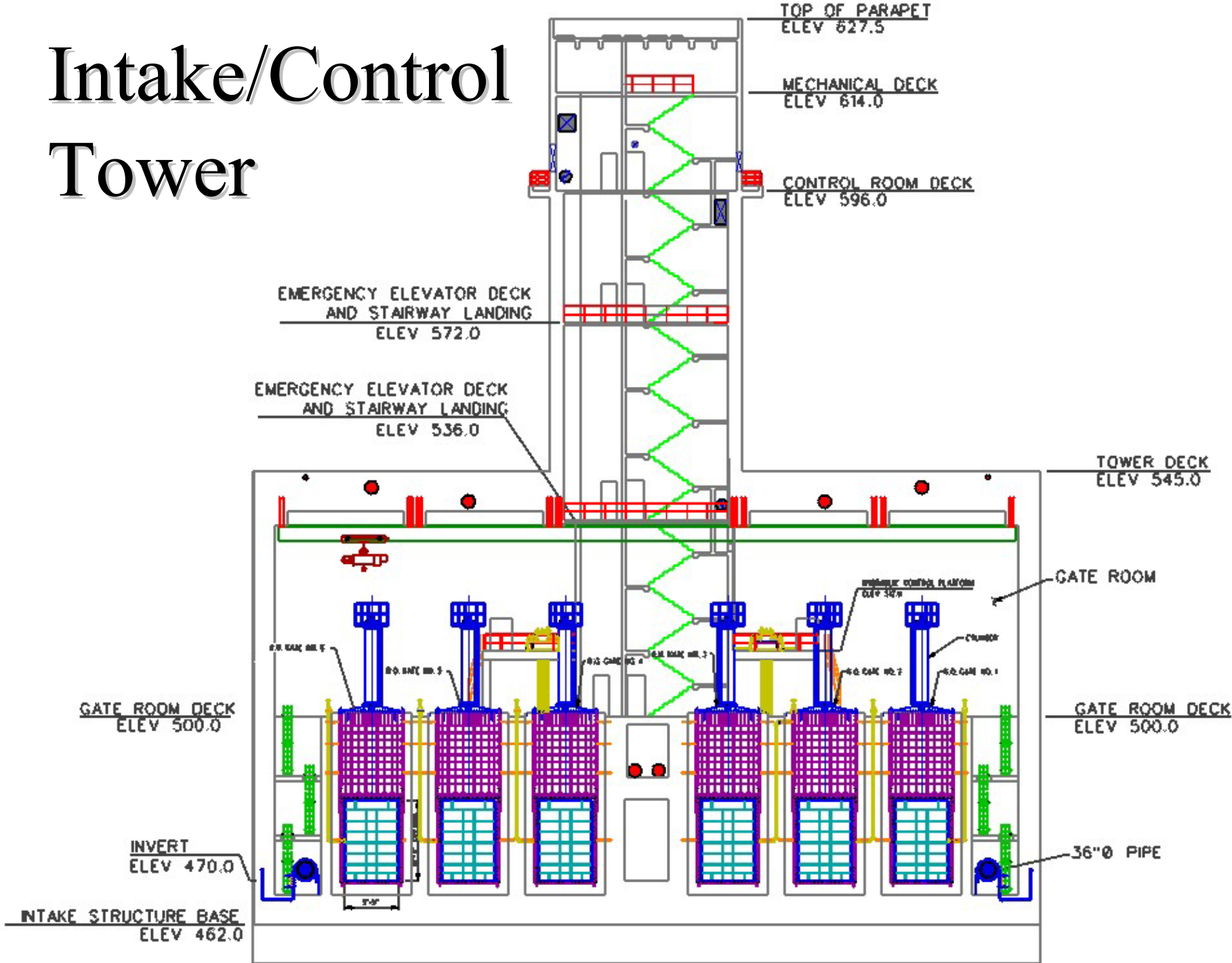





2004 10 1



















## Received Thursday, 6 January 05

From the National Weather Service...

### DISCUSSION:

.TODAY...NO PRECIP EXPECTED.

.FRIDAY...AND CONTINUING ALL THE WAY INTO TUESDAY OF NEXT WEEK...  
AN EXTREMELY WET WEATHER PATTERN WILL IMPACT SOUTHERN CALIFORNIA.  
A TROPICAL PLUME KNOWN AS THE PINEAPPLE EXPRESS WILL BE FEEDING  
MOISTURE INTO A SERIES OF PACIFIC STORMS. HEAVY RAINS WILL CAUSE  
URBAN FLOODING AND MOUNTAIN MUDSLIDES. SOME RIVERS WILL BE  
SUSCEPTIBLE TO OVERFLOW. **THIS WEATHER PATTERN LOOKS SIMILAR TO  
THE ONE THAT PRODUCED THE FLOODS IN THE YEAR 1969.** 50KT WARM  
MOIST SW WINDS FROM 5000 TO 10000 FEET ENSURES THAT ALL SOUTH AND  
WEST FACING MOUNTAIN SLOPES WILL GET HUGE STORM TOTALS FOR THE 5  
DAY PERIOD ENDING TUESDAY.



# Prado Dam Operation

## Jan 1-25, 2005

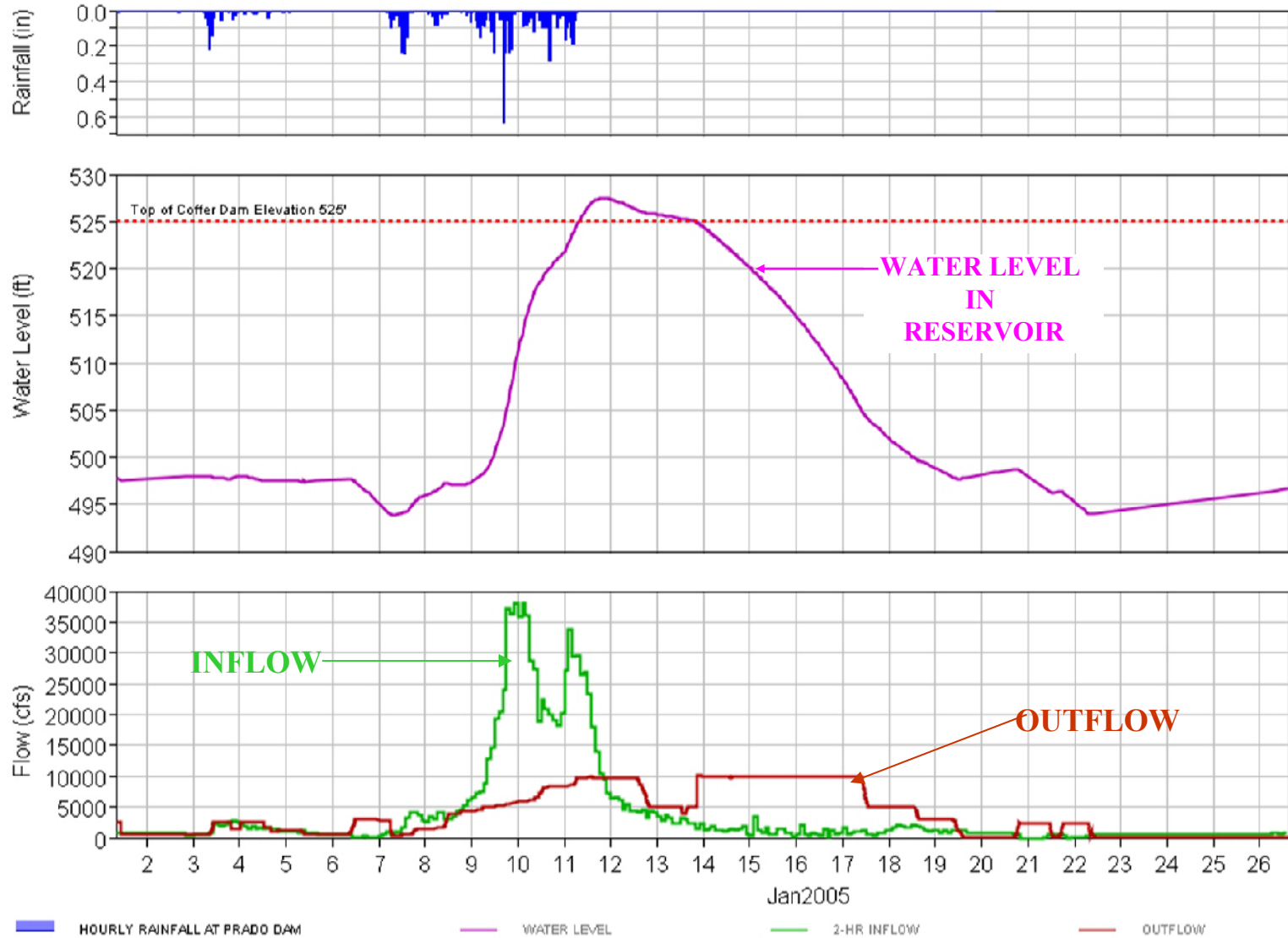



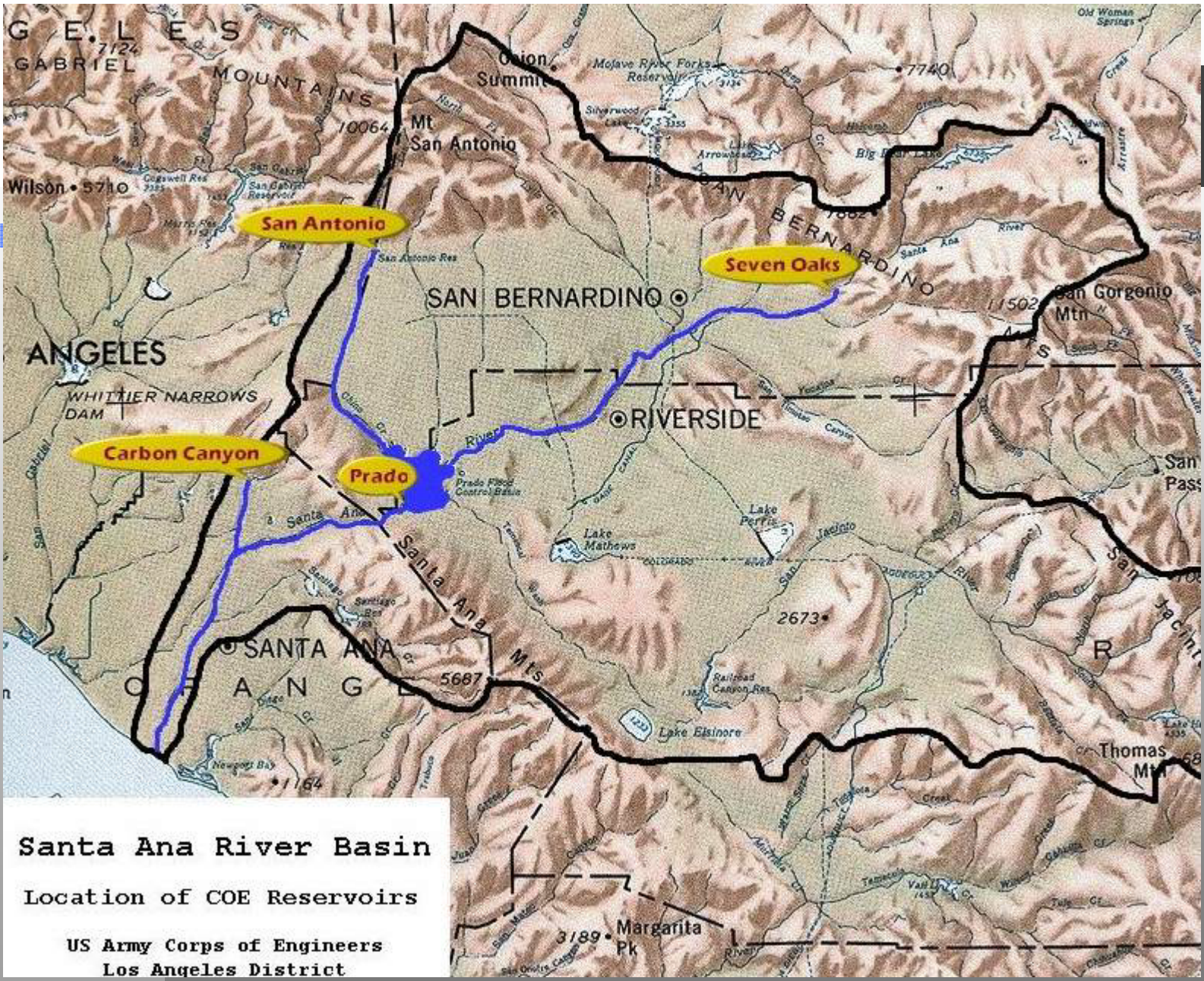

**Santa Ana River Basin**

Location of COE Reservoirs

US Army Corps of Engineers  
Los Angeles District





JAN 10 2005









JAN 11 2005









JAN 11 2005









2005 5 23





2005 1 12















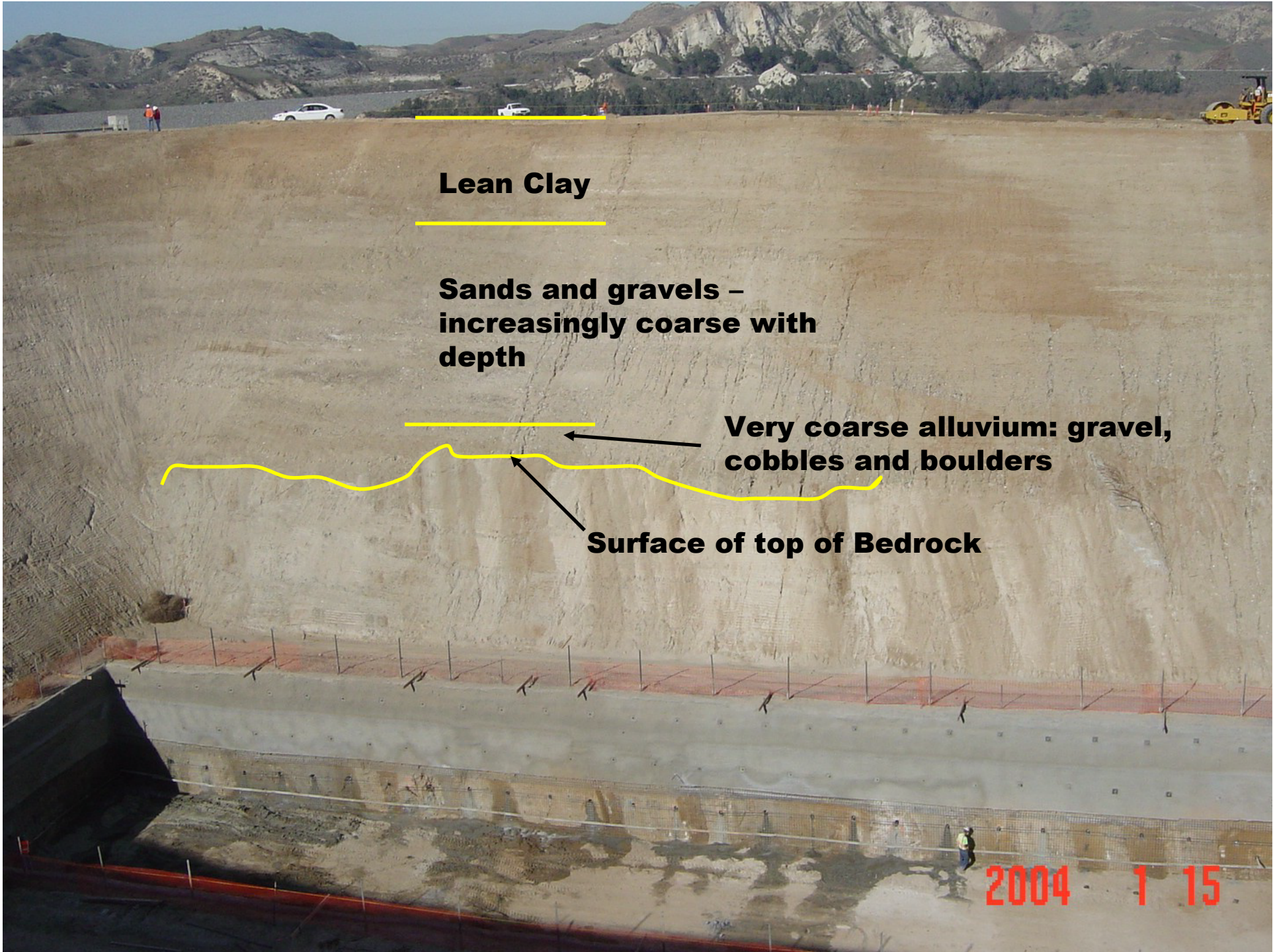

**Lean Clay**

**Sands and gravels –  
increasingly coarse with  
depth**

**Very coarse alluvium: gravel,  
cobbles and boulders**

**Surface of top of Bedrock**

**2004 1 15**





2005 1 19





2005 1 19



**A stability analysis was conducted by the Los Angeles District Geotechnical Group on the “Thin Section” in December 2003. Among other things, the reported concluded:**

**“Catastrophic failure due to seepage will not occur as gradient would be much less than critical”**



# Stage 1 – Grading Plan

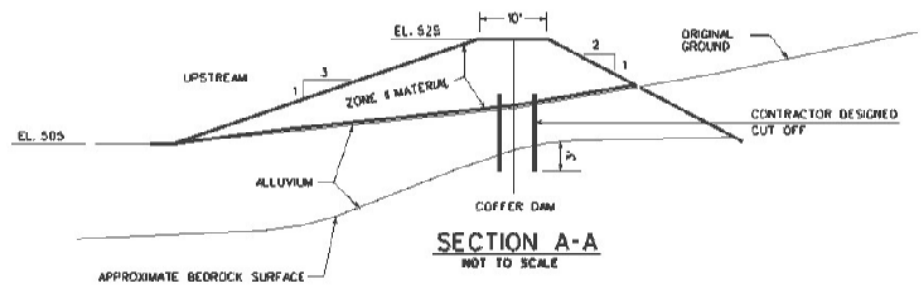
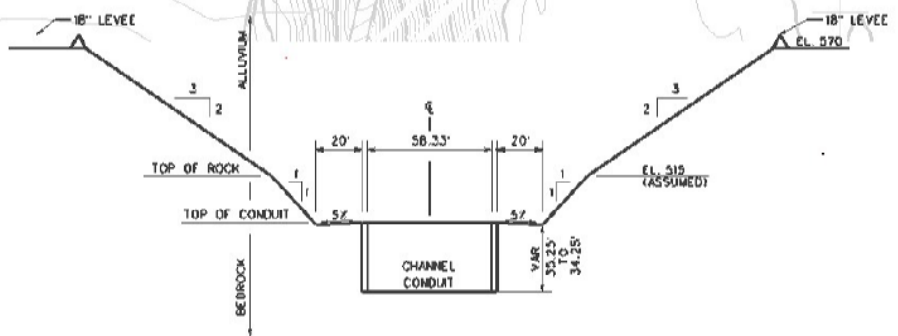
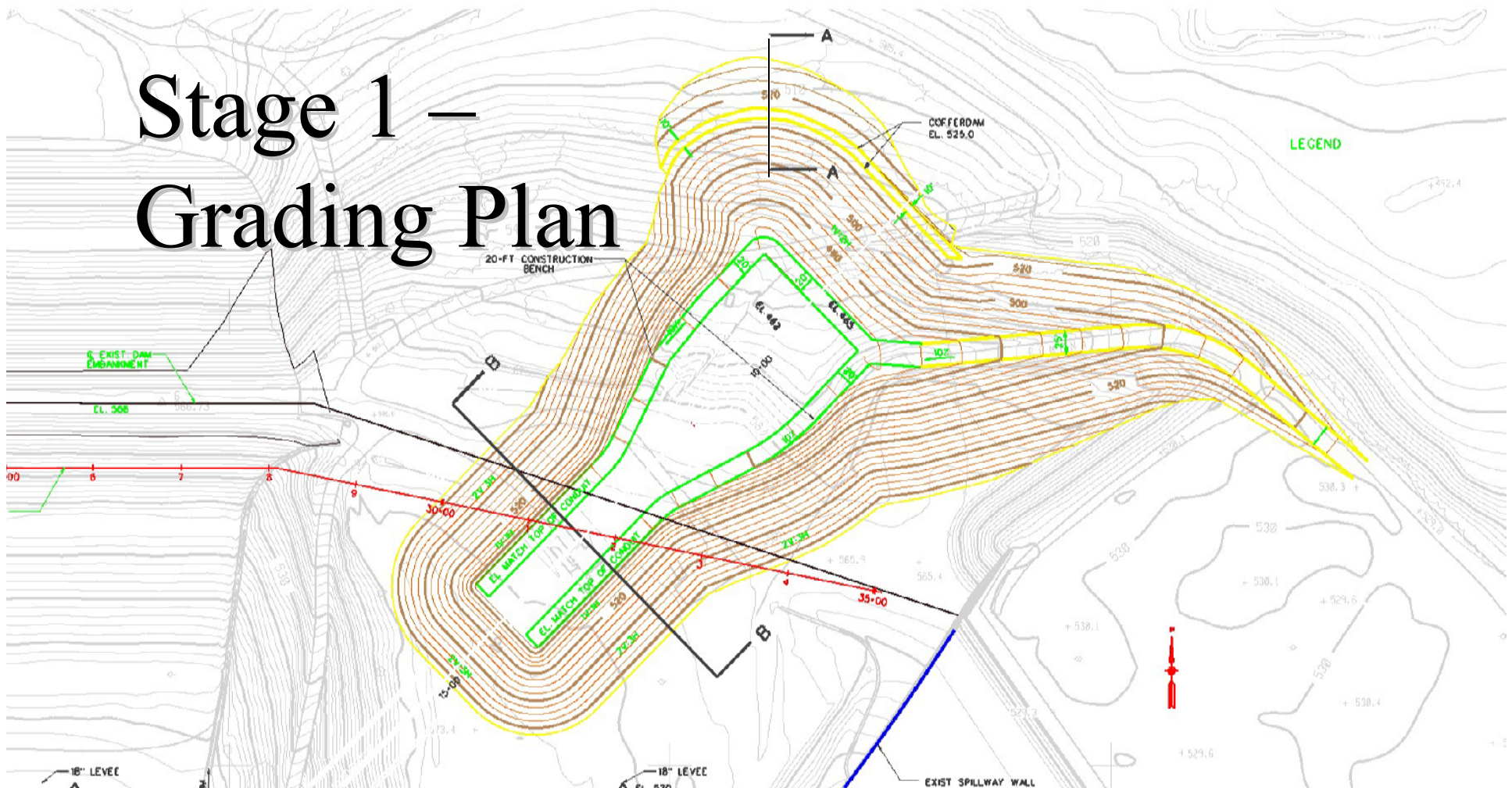



# Simplified Plan View – Left Abutment

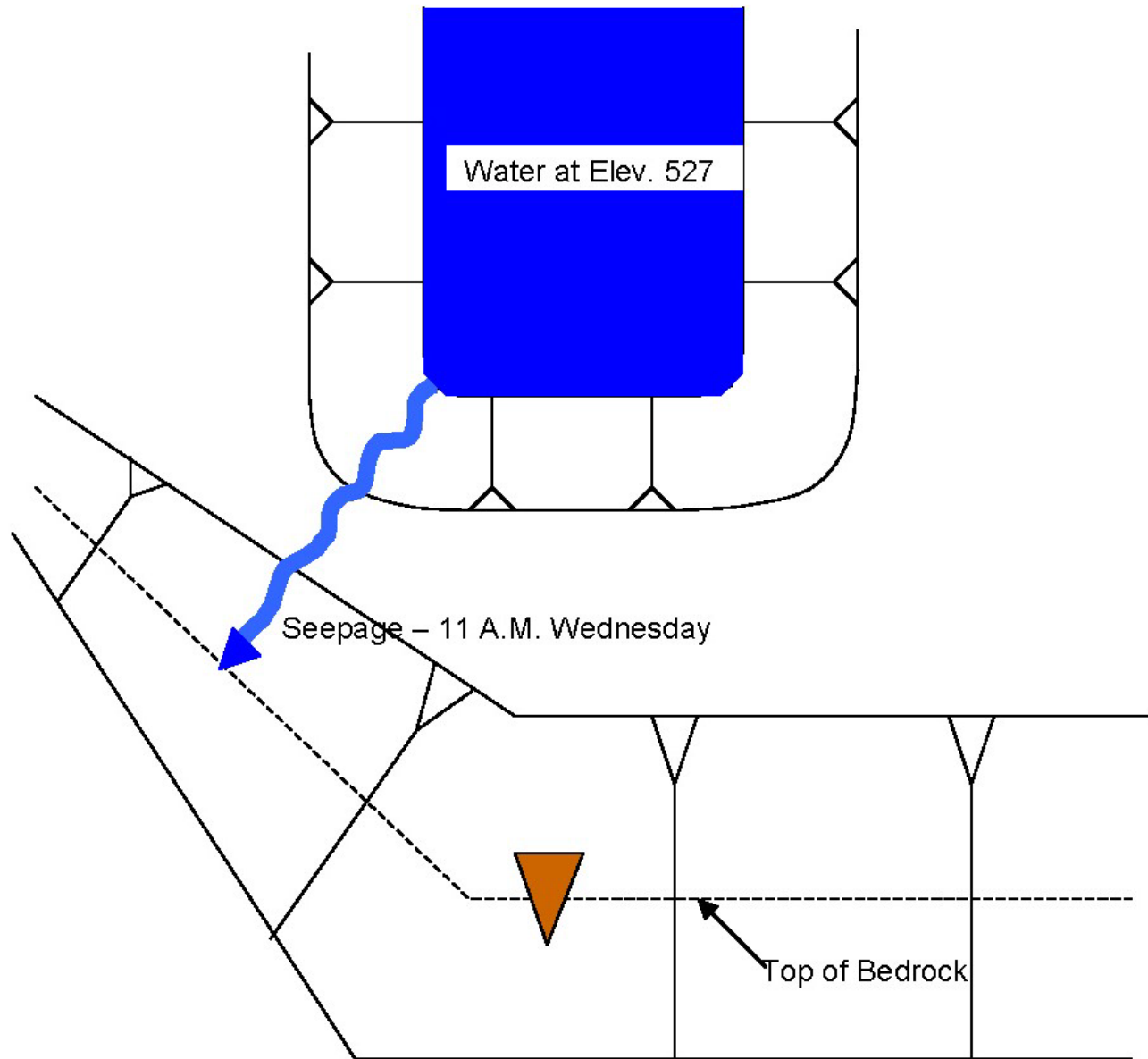



# Simplified Plan View – Left Abutment

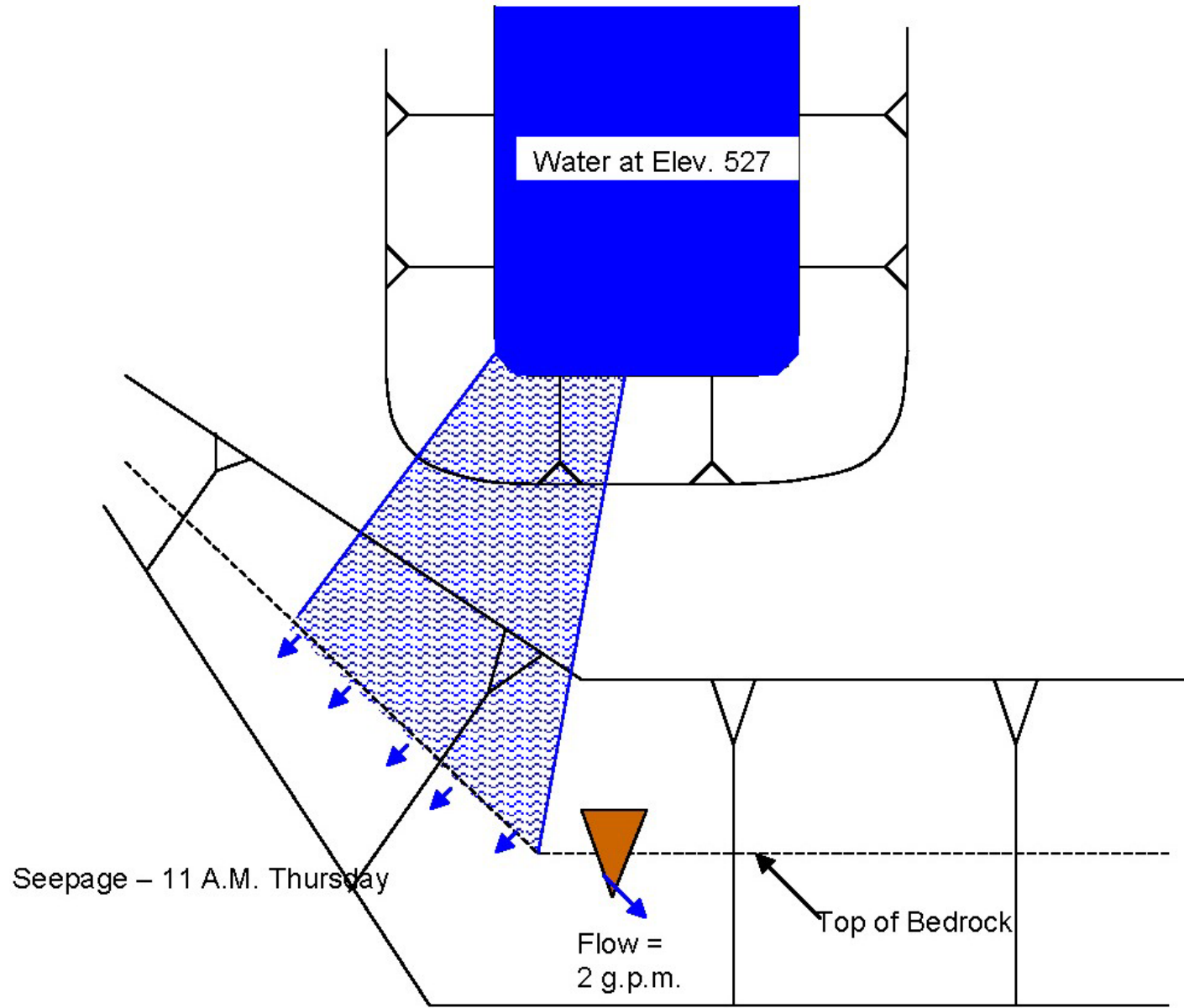



# Simplified Plan View – Left Abutment

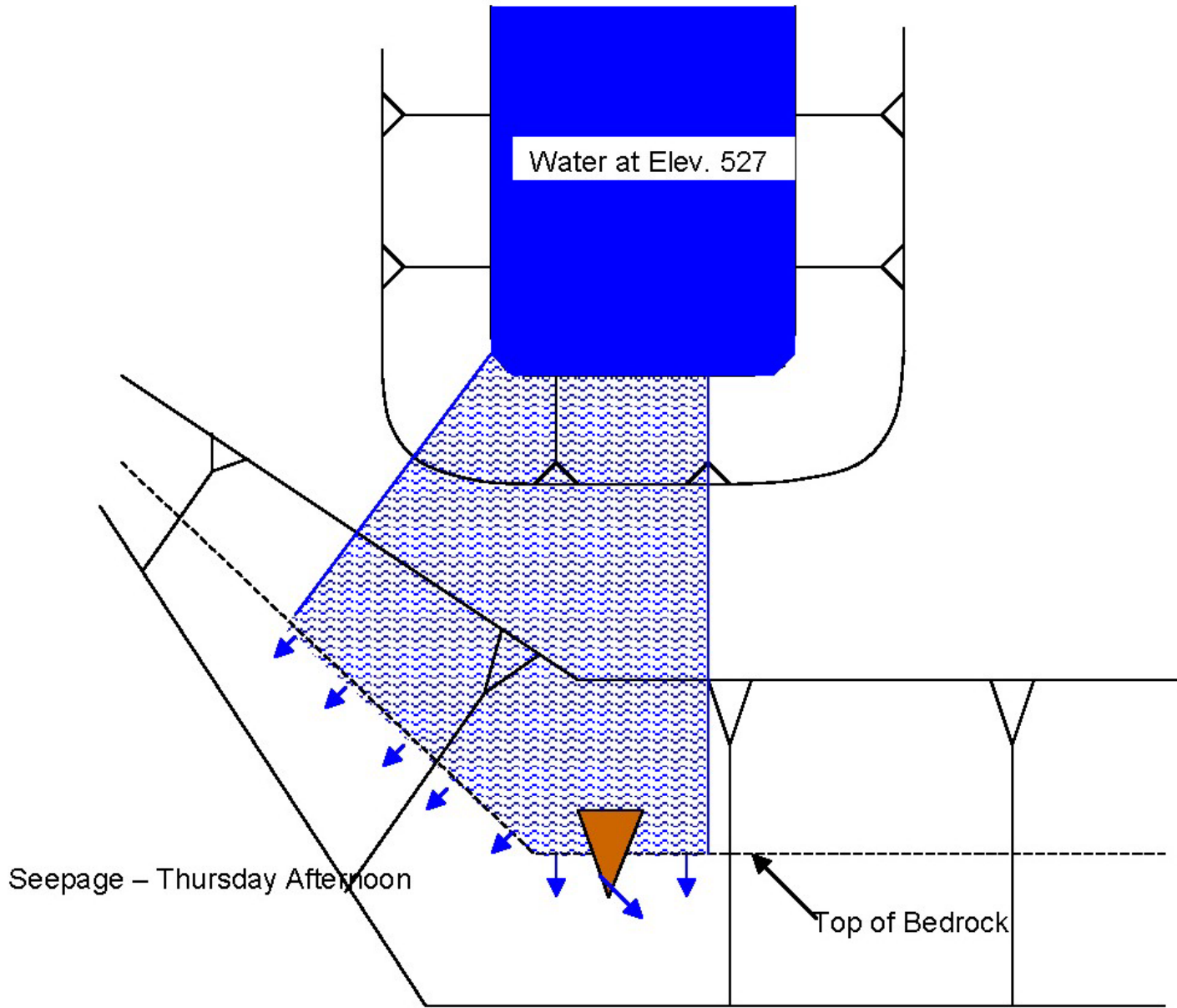



# Cross-Section through Thinnest Section of Left Abutment

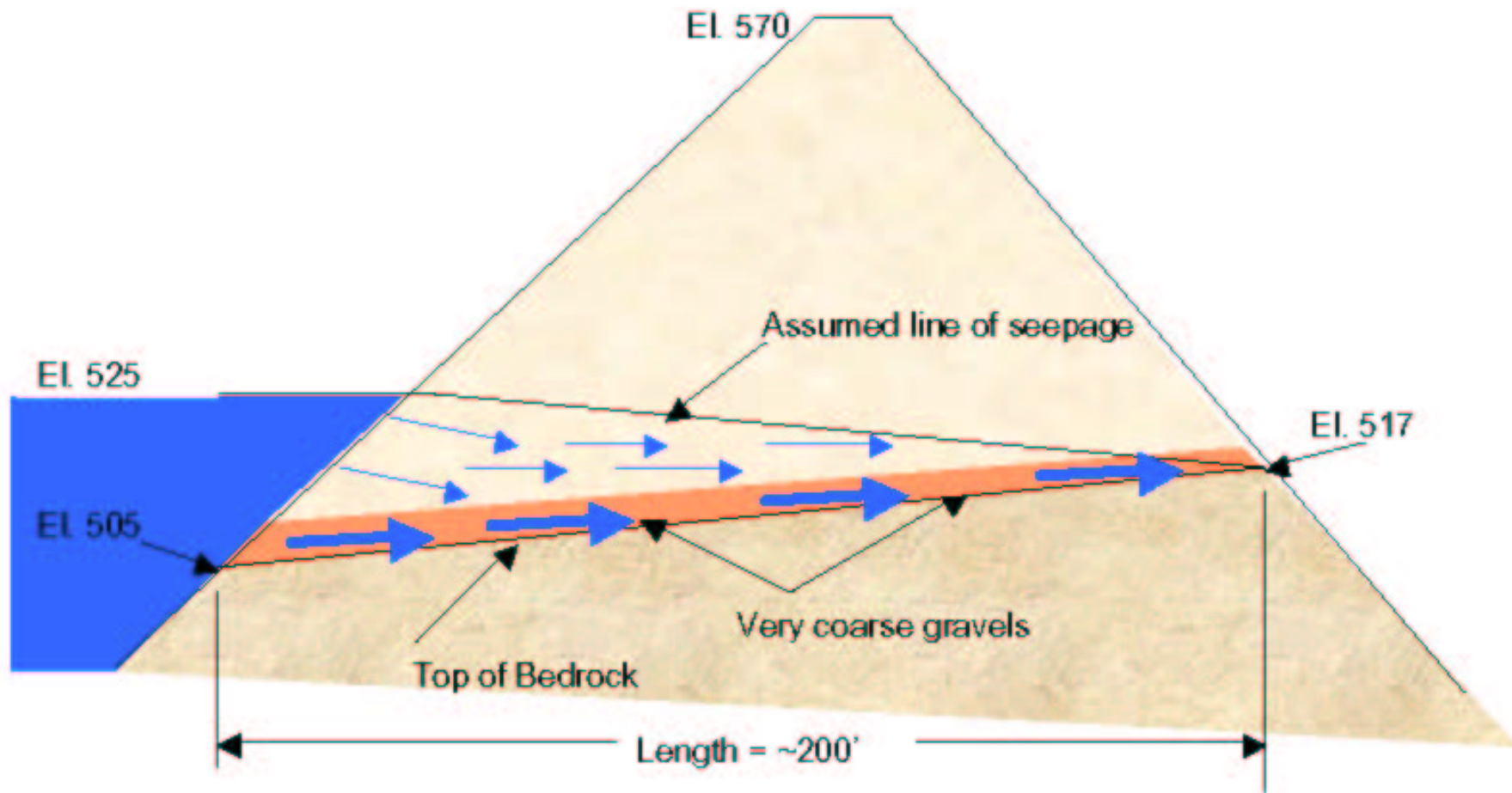





2004 8 1





- 2 gpm of seepage
- Water cloudy, but not muddy
- Flow rate, clarity constant

2005 1 14



# LA District's Opinion on the Seepage

- Predictable, given the site geology
- Quantity of seepage increased as the saturation front developed
- Low head, low exit gradient
- No cause for concern, but “V-Trench” must be monitored







# Small leak, big response

Easy repair needed when water seeps from Prado Dam after recent deluge, prompting Corona, O.C. evacuations.

By **PAT BRENNAN**  
and **AMANDA BECK**  
THE ORANGE COUNTY REGISTER

A leak at Prado Dam on Friday that initially worried city and county officials, prompting evacuations, turned out to be small and relatively easy to repair. But it served as a powerful reminder of the enormous force of the water that fell on Southern California during more than four days of rain that rapidly filled the basin behind the dam, just northeast of Orange County.

**Q: What caused the leak?**

**A:** Construction crews with a contracting firm, Yeager-Skanska Inc. in Riverside County, are raising the dam by 28 feet to provide increased flood protection for Orange County.

They are also installing a



cial. Early Friday morning, Army Corps engineers thought there could be a small chance that the leak

## Prado Dam springs a small leak

A small leak in Prado Dam prompted evacuations of more than 2,000 people Friday. The leak, in the

**OVERFLOW**

An outlet Prado Dam releases water at high capacity Friday, when a leak at the dam caused evacuations of more than 2,000 in nearby homes. The leak, in the face of the dam, developed after heavy flow from the recent storm filled a pit is normally placing pressure on the dam.

BRUCE  
CHAMBERS,  
THE REGISTER

**Floods and  
flood control**



# 1,000 people evacuated by Corona dam

**State:** Seepage threatened to flood area; release eases pressure.

**By Ryan Pearson**  
Associated Press

CORONA — Authorities released a fierce, brown river of water from a Riverside County dam and evacuated more than 1,000 people from its path Friday after a temporary earthen barrier at the site began seeping water.

The U.S. Army Corps of Engineers unleashed more than 10,000 cubic feet of water per second to relieve pressure on the earthen dam 50 miles east-southeast of Los Angeles after more water than usual began pushing through the dirt of a temporary coffer dam that is protecting workers who are extending and raising the dam.

"That's like a swimming pool every second," Corona Mayor Darrell Talbert said.

The water gushed into the Santa Ana River, whose banks were deep enough to handle the flow without flooding, said Lt. Col. John Guenther, deputy commander of the





# Residents leery over returning

CONTINUED FROM A1

Officials with the Army Corps of Engineers, which had been raising the dam to increase flood protection, said they were satisfied with the repair job, adding that the seepage of as much as 10 gallons a minute was minor and didn't threaten the dam's safety.

"The pressure behind the dam was the most ever, more than it's had since it's been built," spokesman Fred-Otto Egeler said. "We had to release pressure from the dam but there was no imminent danger. It wasn't us who declared it a disaster."

The seepage developed Thursday night after weeks of heavy rain raised the water above a temporary barrier called a cofferdam that was designed to protect workers and the construction project.

Water spilled over the cofferdam and put pressure on a naturally occurring embankment of bedrock, gravel and soil alongside the dam. Earthmovers had carved into the embank-

**STOPPING A LEAK:** Seepage was discovered Thursday on the downstream face of Prado Dam where construction was being done on the new intake gate and outlet works. The Army Corps of Engineers took immediate steps to correct and repair the problem.

## The problem:

- The temporary dirt cofferdam was built 65 feet high to keep water out of an area excavated for construction.
- Recent heavy rains caused Prado Reservoir to rise to 67.4 feet, which flooded the area.
- Water seeped through the hill that is part of the earthen dam.

## The solution:

- Water being released from the dam has been increased from 5,000 to 10,000 cubic feet per second to drop the reservoir level and relieve pressure on the dam.
- The face of the dam where seepage has been found is being shored up with additional dirt.
- The seepage area is being reinforced with a fine mesh called geotextile to keep it stabilized.

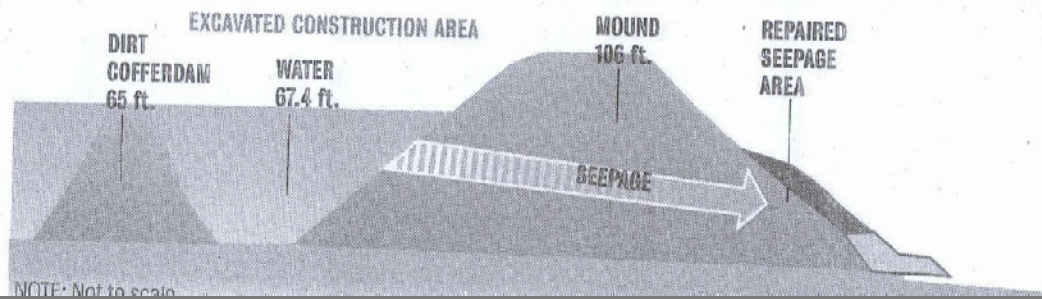
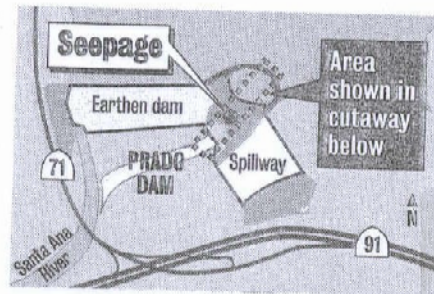

but it's good to be informed," Trifunac said. "I don't want to scare you or leave the wrong impression, but dams are complex structures and it takes a lot of looking at details to know what is going on."

If he lived downstream from the Prado Dam, Trifunac said, "I would invite some very knowledgeable people who design dams to give a talk."

The Prado Dam was built in 1941 to protect then-agricultural Orange County from repeated floods, and that protection enabled the later suburbanization of that region.

David Moreno recalled his father's escape in the late 1930s from a flood that killed a thousand head of cattle and forced his family from the rural town of Prado.

"He had to run for his life," said Moreno, 54, of Norco. "From the time they could get out of the house and climb to where Highway 71 is, it flooded that quick."

The Army Corps of Engineers



**BATTLE OF THE BOONDOGGLES (LIGHT-RAIL DIVISION) • DON'T BLAME GOD IF PRADO DAM BREAKS  
NU-METAL GODS HELMET • THE MAN WHO LOVED TWO BRAINS: SONTAG AND KAE**

# OC WEEKLY

FREE



**NECKFACE'S DEVIL,**  
THOMAS CAMPBELL'S ABSTRACTS  
**AND ED TEMPLETON'S**  
SAD LITTLE MONSTERS  
**HELP MAKE**



## Events of Thursday Evening, 13 January 2005

- **1500 hrs.** I inspect area and note the seepage area had expanded (approx 200 sq ft) but no velocity increase. Rate approximately 20 gpm. No piping of fines were observed. Approximately 2 gpm still out of V-trench. I met with YSI CQC and earthwork foreman to discuss potential actions should situation deteriorate. Briefed RE that I did not see a problem at this time.
- **1700 hrs.** I leave site for the evening.
- **1730 hrs.** At request of YSI CQC representative, their geotechnical consultant arrives to inspect site. He did not share my confidence.
- **1930 hrs.** Corps Dam Expert, after speaking with Contractor's consultant, understands that seepage was now "15 times greater than 24 hours ago, that it contained fines, that headward erosion and sloughing were observed along the gravel and cobble layer and that the consultant believes a stability berm is needed immediately."
- **1930 hrs.** Speaking to RE, Corps Dam Expert concurs with consultants recommendation to mobilize the contractor's equipment to begin construction of the stability berm and increase discharge to 10,000 cfs.



## Events of Thursday Evening, 13 January 2005

- **2022 hrs.** Reservoir Operations begin to ramp up releases.
- **2100 hrs.** I returned and found no significant change in seepage. Request my supervisor and Byron Rathbun (7 Oaks Dam embankment engineer) to come to the site and provide additional opinions.
- **2200 hrs.** Mr. Rathbun and Mr. James Farley, Chief of Soils Design and Materials Section, arrived and inspected the site. Both concurred that the seepage did not merit mitigating measures at that time.
- **2200 hrs.** Contractor requests California Highway Patrol assist with traffic control when they arrived at the dam. Corona PD hear CHP radio traffic about closing Hwy 71 to get additional construction equipment to Prado and informed the Corona Fire Department.
- **2300 hrs.** District Commander directs RE to begin construction of the buttress for preventative measures.



# So why did Prado make the news?

1. Extremely large event – record 5-day inflow
2. Inaccurate information
  - Seepage volume increased, not seepage velocity
3. Incorrect assessment
  - GE believed seepage to be carrying fines.
  - Mistook a small localized slump for headward erosion
  - He did stability not seepage/piping analysis.
4. Unnecessary recommendation – lead to emergency mobilization
5. Poor communications with locals



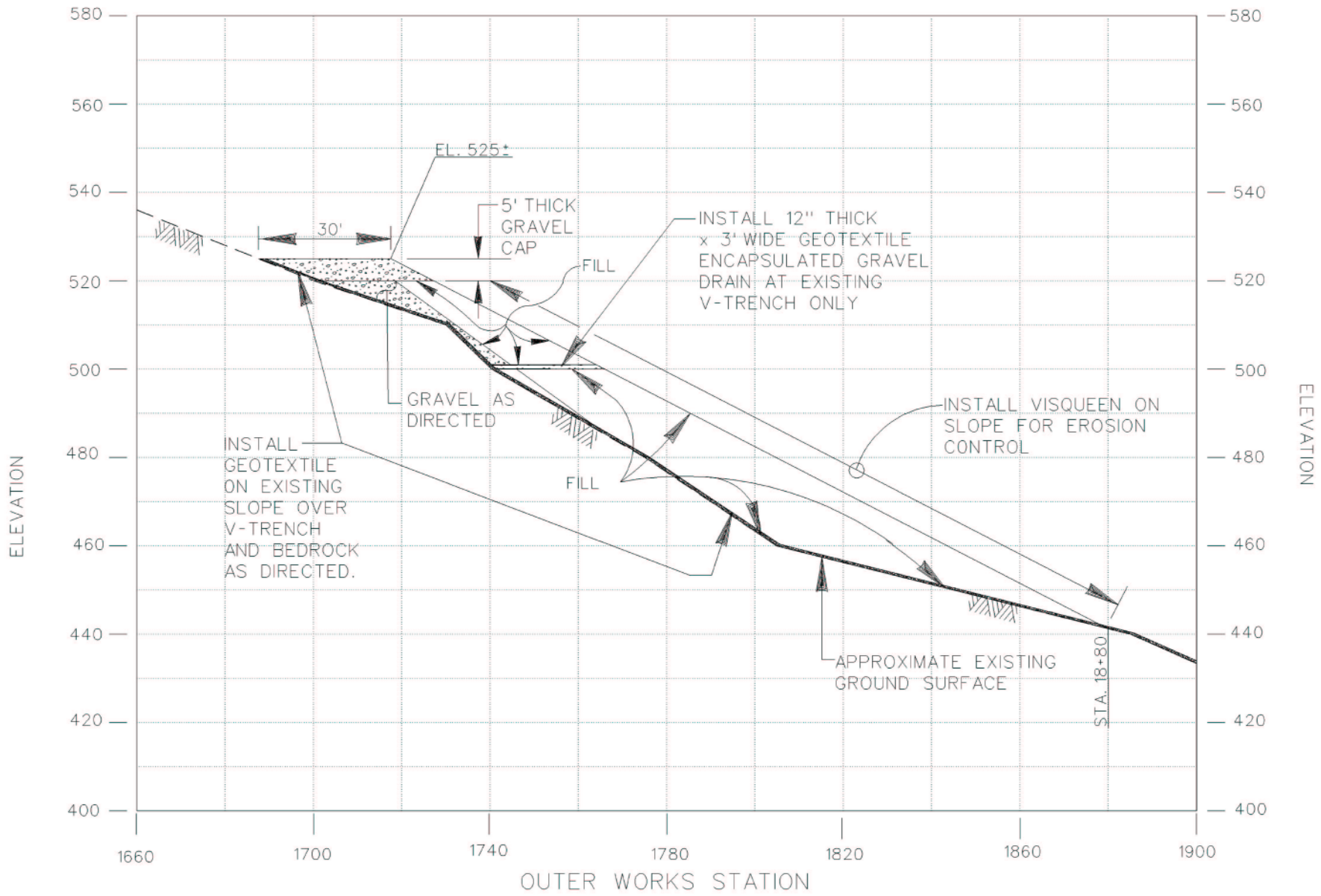

**BUTTRESS FILL SECTION**  
 SCALE: 1" = 20'









2005 1 15





2005 1 15









Careful, the beverage you're about to enjoy is extremely hot.





Dung





# Lessons Learned

1. Anticipation: I should have anticipated that this could be a concern and have fully briefed the RE
2. Coordination: Even experts need to work through people experienced at the site
3. Communication: We did a poor job apprising the locals of what we were doing and why



**Thank you**



2005 2 23