

ORDNANCE AMMUNITION

THE FUTURE PERSPECTIVE

COL MICHAEL T. McBRIDE

Deputy Commander / Chief of Staff
US Army Ordnance Center and School

Presented to:

Precision Strike Association/NDIA
Armaments Technology Firepower Forum

11 June 2008

GO ORDNANCE!



PURPOSE



BLUF: OD Corps continues to execute core competence to ARM THE FORCE and work with the total ammunition logistics community to support Soldiers and shape the future of ammunition logistics

BRIEFING OUTLINE

- OD Ammo Team
- OD Corps in Sustainment Center of Excellence
- Change in OD Corps Support
- OD Ammo Vision 2030
- OD Ammo Log Collaborations/Initiatives



ORDNANCE CORPS AMMO TEAM



Chief of Ordnance – Proponent, Deputy CDR CASCOM

Ordnance Center and Schools

- Ordnance Mechanical Maintenance School
- Ordnance Munitions and Electronics Maintenance School w / TRADOC Munitions System Manager Office OPCON

Combined Arms Support Command

- Capabilities Development and Integration
- Training Development

WE ARE – Ammo **D**octrine, **O**rganization, **T**raining, **M**ateriel, **L**eadership Development, **P**ersonnel, **F**acilities (**DOTML-PF**)

CASCOM

The Sustainment Center of Excellence

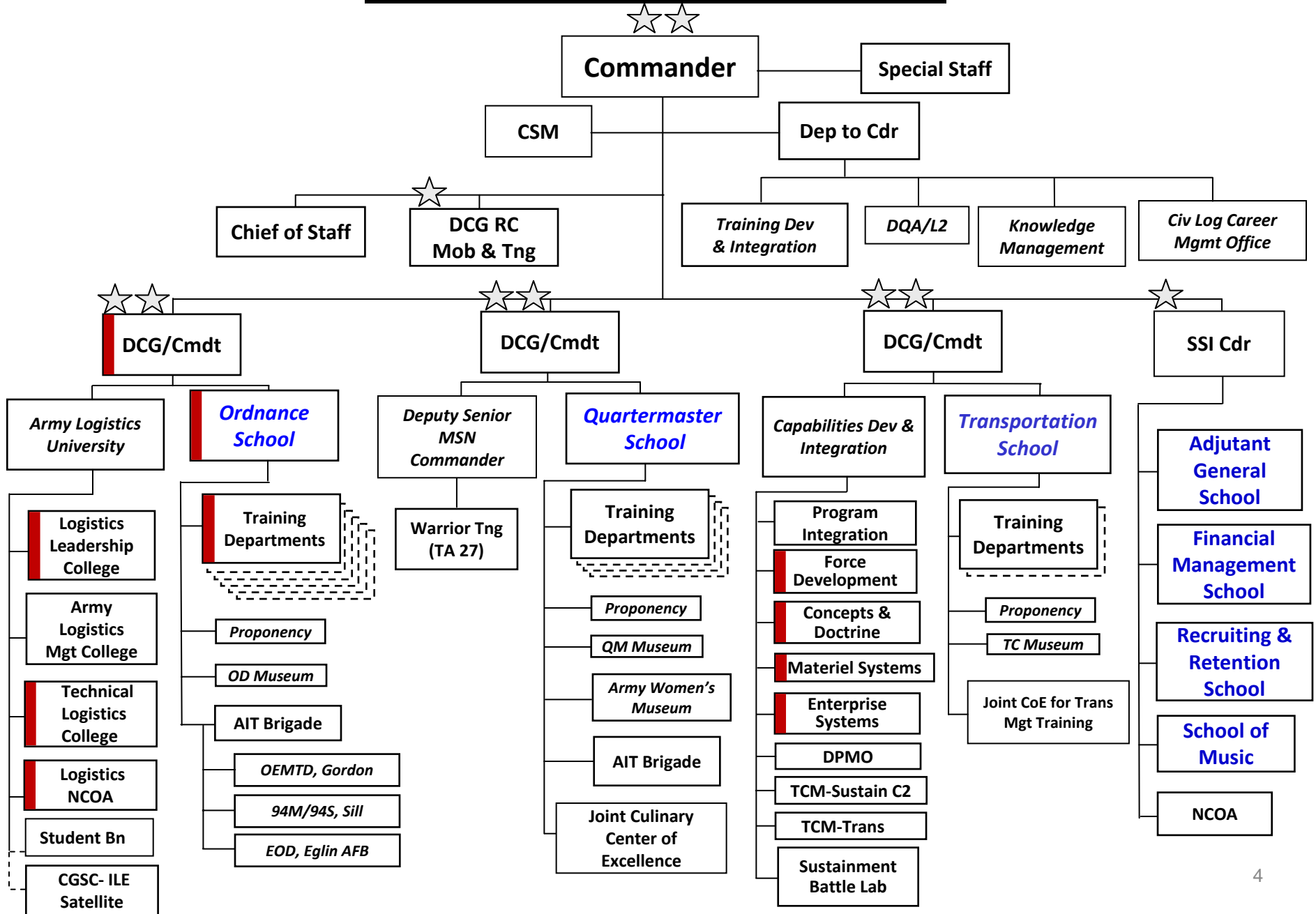



FROM OUR FOXHOLE - NOW



- Army Transformation (BCT, SB, ESC, TSC) is working
- Multifunctional Logistics is necessary and also working
- Ammo Modular Unit Organization - a success story
- Ammo Soldiers
 - Building the force to meet Transformation
 - Training Ammo Soldiers to be Mod Force experts
 - Leader Dev – OD ammo officer Tng/PD a challenge
 - Unit-level proficiency – an on-going challenge
- Ammo Logistics Support Teaming – Improving with great coordination from Army, JMC/DAC, PEOs, ARDEC ammo log leaders



HISTORICALLY



WE HAVE **ALWAYS** BEEN ABLE TO:



RECEIVE



STORE



ISSUE

And ... The OD Corps has been a leader in Log Innovation!

- Maneuver Oriented Ammo Distribution System – 1987
- MOADS PLS – 1989
- Container Roll-on – Roll Off Platforms (CROPS) 1997
- Modular Medium/Heavy Ammo Platoons – 1994 concept
- IBCT Ammo Resupply System 2001

BUT...



EVOLVING MISSIONS INCLUDE

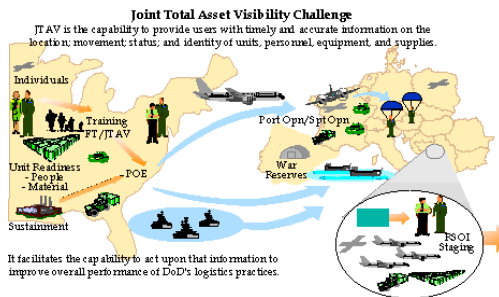

E-2-E Vis/Accountability



Ammo Soldiers in fwd combat resupply opns



Recover-Repkg- Redeploy Issued CL V



Log Self-Protection



Safe Mgt of Ammo / CEA



AMMO SUPPORT - THE TOTAL FORCE



We will support an evolving mix of future forces



Mod Force BCT



Future Force



SBCT

OUR FUTURES CHALLENGE

- Ammo support to High-Low tech mix of forces for the near-mid future
- With limited budget, less log footprint
- Improved Joint support to other services
- Continued support to coalition forces



Wholesale/retail and Direct/General Support

The Lines are fading – FAST

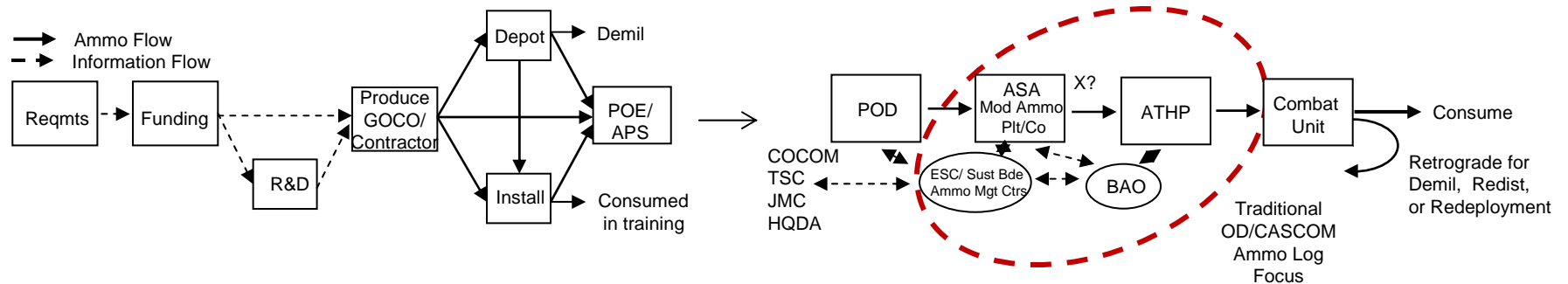

- Ammo Soldiers are operating at combat battalion and lower level
- JMC LARs and DAC QASAS deploy with HQs and sustainment units
- PEOs are rapidly developing and fielding new systems to deployed units
- Contractors perform support missions at all levels including BCTs
- Ammo units are supporting and being trained at installation level
- Experts from all organizations are developing and exchanging LLs and changing TTPs/doctrine, training

The future of ammo logistics requires a new Vision



ORDNANCE AMMO VISION 2030



BACKGROUND

- Ordnance Corps Vision is Dated
 - Pre Modular Force
 - Pre OIF/OEF
 - Considerable change/LL across the spectrum
- Chief of OD directed a new vision
 - “Answer these 3 Questions...”*
 - *Where are we today?*
 - *What has Changed and What is Missing?*
 - *What do we need to look and be like in 2030?*



ORDNANCE AMMO VISION 2030



KEY AMMO ISSUES

- Where (and Who...) are all the Experts? Across the full life-cycle spectrum of ammo logistics
- Professional Development / Military Education
- Skilled BAO teams for the BCT CDR
- Perishable skills lost at home station
- Surveillance & Quality Assurance
- BCS3 vs. MUREP vs. LOGSTAT
- Battlefield Task Migration – New missions, new support elements – not all wearing your patch, some civilians
- Ammo Automation MOS – New 89A
- New families of smart, brilliant, scalable, munitions and missile requiring new handling, packaging, maintenance



ORDNANCE AMMO VISION 2030



AMMO WARRIOR 2030

- Officer
 - Warrant Officer
 - Non-Commissioned Officer
 - Enlisted
 - DA Civilian
 - Contractor
- Each with different areas of responsibility and expertise – but ALL with a solid tactical and technical understanding of ammunition and ammo support systems. They share a common operating picture of the battlefield and status of ammo.



FROM OUR FOXHOLE THE FUTURE



- **Ammo and Ammo Soldiers** – We will have less of both, they will need to be smarter, multi-mission, rapidly deliverable, safe, survivable, accessible, and completely reliable
- **Training** – Life-long, adaptive, integrated across ammo log SME team, best of virtual, on-line, and resident capabilities
- **Information Technology** - Leverage best solutions for ammo accountability, ammo health monitoring, SA, and C4
- **Rearm Systems** – Mobility, survivability, rapid rearm
- **Distribution Platforms and MHE** – Common across the Future Force, designed to fully meet all needs – seamless interface with rearm systems, minimize man-in-the-loop



CURRENT OD AMMO TEAMING



- ❖ **Army G-3** - Munitions Strategic Campaign Plan
- ❖ **Army G-4** - Unit Munitions Visibility, Accountability, Expenditure IPT
- ❖ **PEO Ammo/PD Joint Services** – Ammo Logistics R&D IPT Initiative
- ❖ **ARDEC** - Dev Team member to review munitions supportability analysis, training requirements
- ❖ **DAC and CASCOM Training Dev** – Ammo Training Community of Practice, Knowledge Harvesting
- ❖ **DAC Theater Assessment** – Capturing ammo LLs



A PARTING SHOT



FACT - NO MATTER HOW AMMO LOG UNITS AND MANAGERS HAVE BEEN ORGANIZED, TRAINED, EQUIPPED, DEPLOYED, AND UTILIZED - THE ARMY HAS NOT LOST AN ENGAGEMENT BECAUSE OF A FAILURE OF AMMO LOGISTICS

A GREAT RECORD THAT ALL AMMO LOGISTICIANS CAN PROUDLY OWN ...

AND CANNOT LOSE!



COL MICHAEL T. McBRIDE

Deputy Commander / Chief of Staff

US Army Ordnance Center and Schools

(410) 278-3285 (DSN) 298

CW5 DON DEHNEL

Deputy, TRADOC MSM Office, OMEMS

(256) 876-9179 (DSN) 746



BACKUP SLIDES



- ◆ [Definitions](#)
- ◆ [Briefing Support](#)
- ◆ [Current Theater Operations](#)
- ◆ [Army Mod Force Units](#)
- ◆ [Army Ammo Transformation](#)
- ◆ [OD Training Overview](#)



DEFINITIONS



AOE	Army of Excellence, pre-Mod Force Army organization
APE	Ammunition Peculiar Equipment
APS	Army Pre-positioned Storage
ASA	Ammo Supply Activity, any ASA in theater
ASP	Ammo Supply Point, receives, stores, issues ammo to units
ATHP	Ammo Transfer and Holding Point, mini-ASP at BCT level
ATP	Ammo Transfer Point, AOE Div team to
BCT	Brigade Combat Team
CEA	Captured Enemy Ammunition
COP	Community of Practice or Common Operating Picture
ESC	Expeditionary Support Command
E-TO-E	Joint End to End distribution process
IBCT	Interim Brigade Combat Team
IPE	Industrial Plant Equipment





DEFINITIONS (CONT...)



LHS	Load Handling System, similar to PLS but on HEMTT truck
MHE	Materiel Handling Equipment (forklifts/cranes)
MOADS	Maneuver Oriented Ammo Dist System, a distribution-based ammo spt system that moved Army away from supply point support
PD	Professional Development
PLS	Palletized Load System – self-loading truck and platform system
POD/POE	Port of Debarkation/Embarkation
QASAS	Quality Assurance Specialist (Ammo Surveillance)
SA	Situational Awareness
SB	Sustainment Brigade, Mod Force primary support unit
SBCT	Stryker Brigade Combat Team
TAV	Total Asset Visibility
TMDE	Test, Measurement, and Diagnostic Equipment
TSC	Theater Support Command
TTP	Tactics Techniques, and Procedures



CASCOM Today

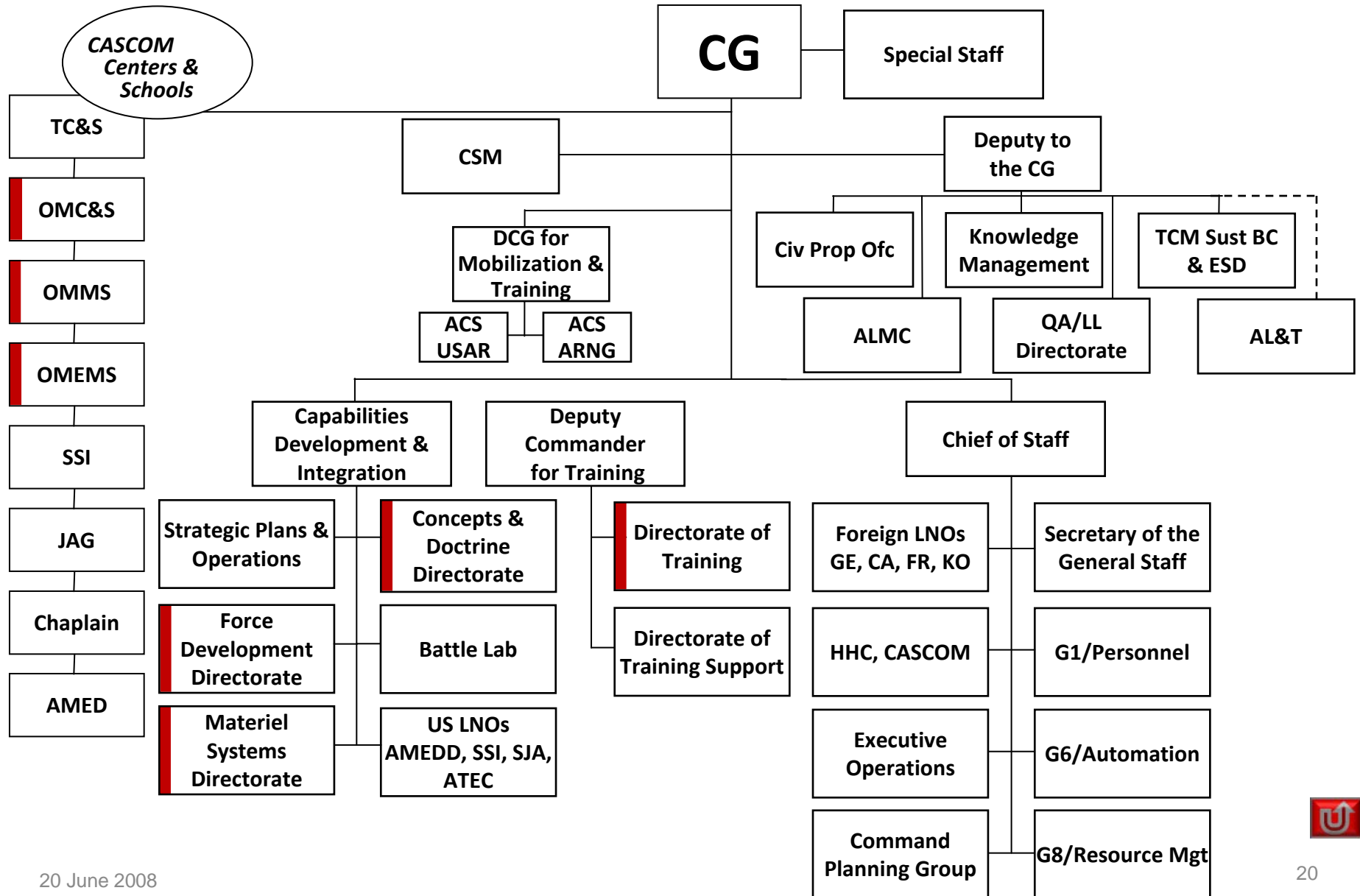



AMMO LOGISTICS



“The Future Ain’t What it Used to be”

1988

- Warsaw Pact
- Extreme Lethality
- Primarily Conv CL V
- Army, Joint/Cbd
- AirLand Battle Force
- Linear Battlefield
- Fwd Based Forces
- Supply Point Log
- Pre MOADS-PLS
- Breakbulk Ammo

2008

- GWOT
- Measured Lethality
- Conv/Precision Mun
- Army evolving to Joint
- BCT-SBCT- Mod Force
- Non Linear Battlefield
- Mixed - Expeditionary
- Supply Pt/Dist Mixed
- Flex Mod Log PLS/LHS
- CROPS, Mix CL/Single

2018

- Full Spectrum Threat
- Selective Lethality
- Precision Munitions
- Joint Forces
- Mod/Future Force
- Noncontiguous
- Joint – Expeditionary
- Dist Based Logistics
- CLV Pkg/Auto Rearm
- Constrained Budget
- Reduced Log Foot

We’ve come a long way, but – a long way to go...





AMMO LIFECYCLE

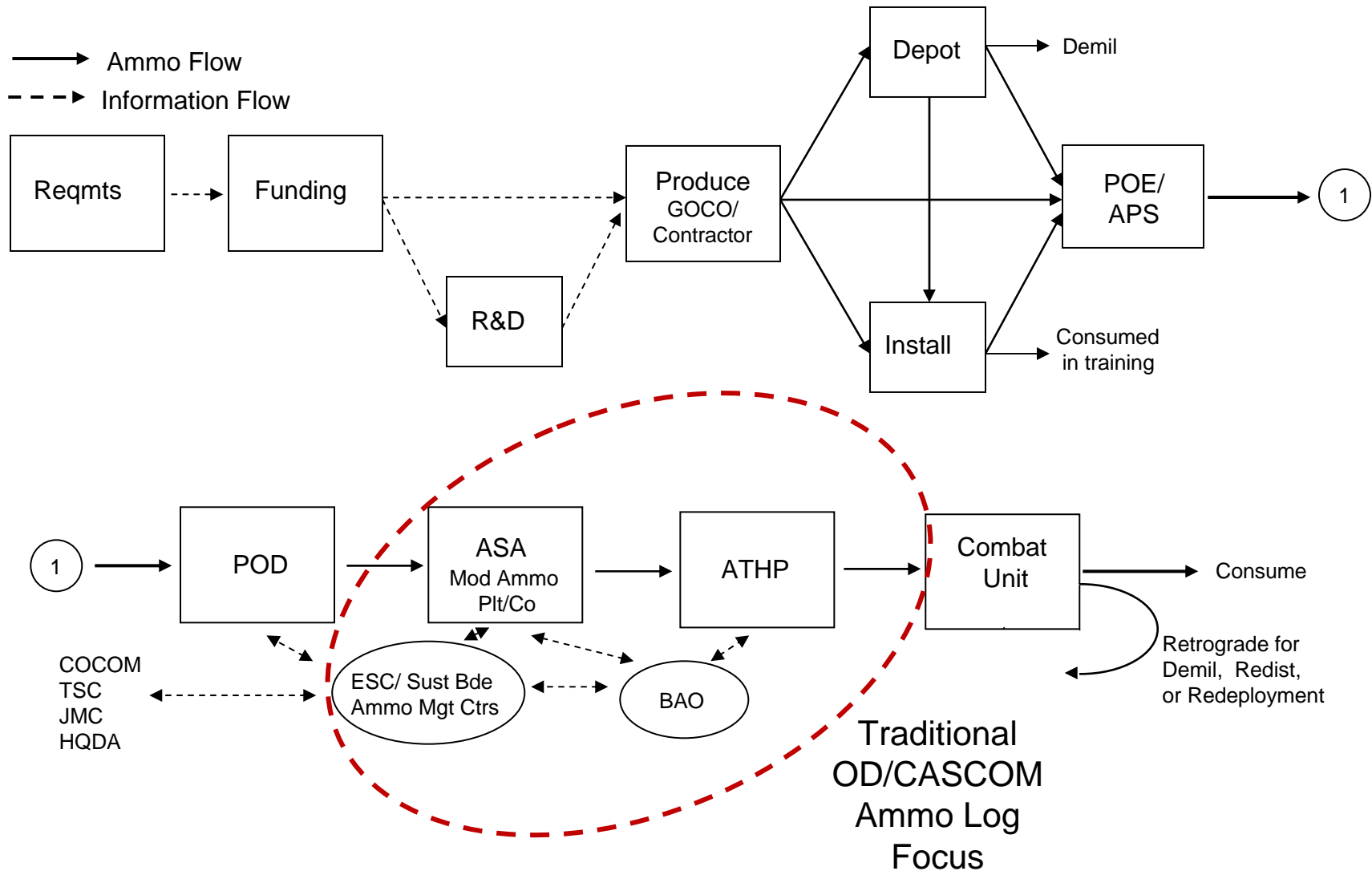



ORDNANCE AMMO VISION 2030



CHIEF'S GUIDANCE:

● Three Core Competencies:

- Maintenance
- Ammo
- EOD

● Bring the full spectrum of ammo stakeholders together –
Army Staff, DESB, AMC, TRADOC, PEO Ammo, JMC/DAC, CASCOM,
OC&S, HRC, USAR, others

● Completed May 2008





ORDNANCE AMMO VISION 2030



MAJOR TOPICS

- **Equipment:** Munitions, MHE/APE/IPE, Info Tech, Distribution, TMDE, Packaging/Handing
- **Organizations:** Integrated - tactical to Strategic, Joint, Modular, Split-Based, Full Lifecycle Functions
- **Training:** Tactical/Technical, core munitions competencies, career-long path, certification, best mix of virtual, web-based, and resident training
- **Reach Capabilities:** True TAV/SA, tele-presence, direct, real-time knowledge collaboration/management



Current Theater Ammunition Operations

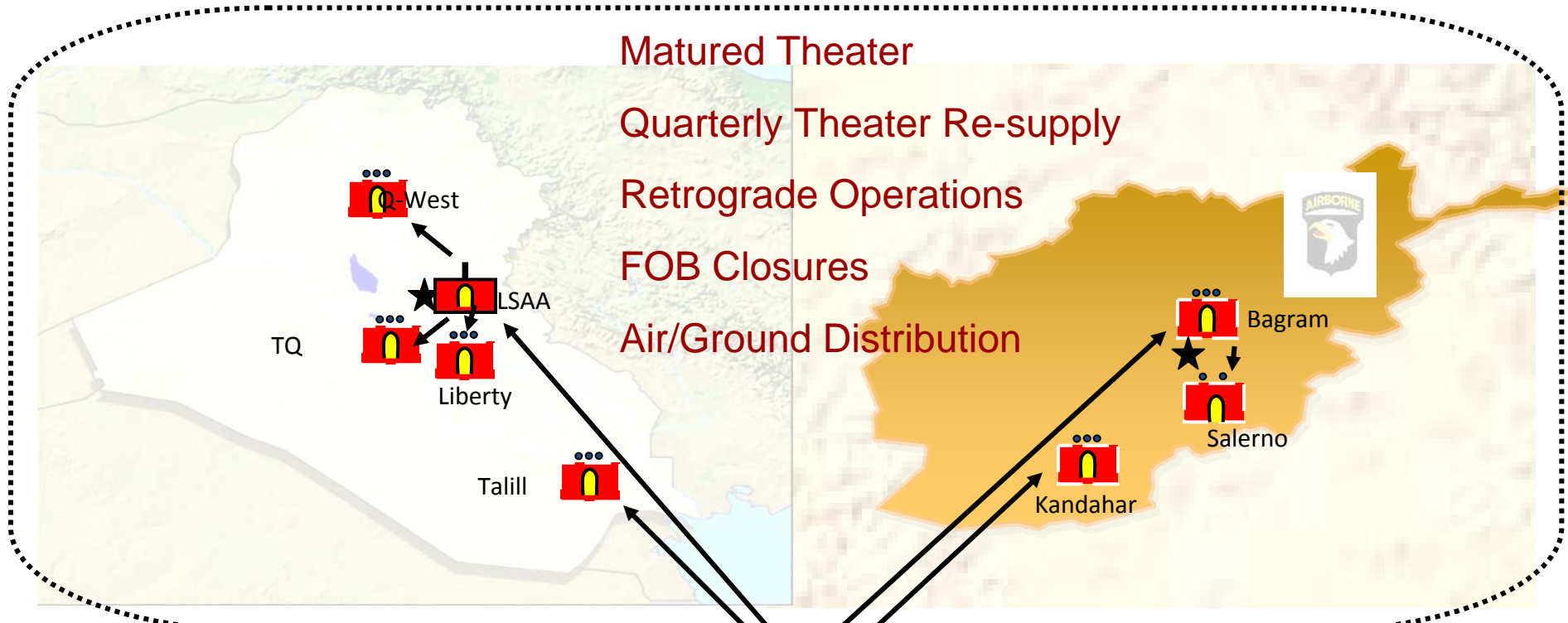

1st TSC
Redeployed
back to Ft.
Bragg

ESC
SB x5
ASA x5
ATHPs(19)

OIF
316th/3rd ESC



KUWAIT
311th

GO ORDNANCE!

ESC
TSA
ASA x2

JLC
SB (-)
ASA x3
ATHPx3

OEF
101st SB





ARMY SUPPORT UNITS



TSC (3 WO)

1st TSC Ft. Bragg
8th TSC Hawaii
21st TSC Germany

Red is a part of Grow the Army - GTA

ESC (2 WO)

3rd ESC Ft. Knox
13th ESC Ft. Hood
?? Ft. Lewis
19th ESC Korea

Sustainment Bdes (currently 2 WO going to 1)

1st SB Ft. Riley
3rd SB Ft Stewart
4th SB Ft. Hood
7th SB Ft. Eustis
10th SB Ft Drum
15th SB Ft. Hood
16th SB Germany
29th SB

43rd SB Ft. Carson
45th SB Hawaii
64th SB
82nd SB Ft. Bragg
101st SB Ft. Campbell
501st SB Korea
507th SB
593rd SB Ft. Lewis





ACTIVE DUTY AMMUNITION UNITS



- 3 Ord BN-none are true Ord Bn w/numbered TOE Ammo Co's:
 - 80th Ord Bn, Ft. Lewis, WA (to convert to a CSSB w/AAE)
 - 83rd Ord Bn, Japan (to convert to an CSSB w/AAE)
 - 6th Ord Bn, Korea
- 5 Ord Companies CONUS*
 - 8th Ord Co, Ft. Bragg, NC (HQ & 3 plts)
 - 24th Ord Co, Hunter Army Airfield, GA (HQ & 5 plts)
 - 60th Ord Co, Ft. Carson, CO (HQ & 3 plts)
 - 63rd Ord Co, Ft. Lewis, WA (HQ & 3 plts)
 - 664th Ord Co, Ft. Hood, TX (HQ & 5 plts)
- OCONUS*
 - 23rd Ord Co, Germany (HQ & 2 plts)
 - 17th Ord Co, Korea
 - 52rd Ord Co, Korea
 - 84th Ord Co, Korea

*Permanent station - units/plts may be deployed





BCTs



BCTs (48-Endstate)

Ft. Benning (1 - HBCT)	Alaska (2 – IBCT(ABN)/SBCT)
Ft. Bliss (6 – 4 HBCT/2 IBCT)	Germany (1 – SBCT)
Ft. Bragg (4 – IBCT(ABN))	Hawaii (2 – IBCT/SBCT)
Ft. Campbell (4 – IBCT)	Italy (1 – IBCT(ABN))
Ft. Carson (5 – 3 HBCT/2 IBCT)	Korea (1 - HBCT)
Ft. Drum (3 – IBCT)	
Ft. Hood (4 – HBCT)	
Ft. Knox (1 – IBCT)	
Ft. Lewis (3 – SBCT)	
Ft. Polk (1 – IBCT)	
Ft. Riley (3 – 2HBCT/IBCT)	
Ft. Stewart (4 – 2 HBCT/2 IBCT (1 – IBCT))	
White Sands Missile Range (1 – HBCT)	

Red is a part of Grow the Army - GTA





FIRES AND AVN (CAB) BDES



Fires Bdes (6)

- 1 – Ft. Bliss
- 1 – Ft. Bragg
- 1 – Ft. Hood
- 1 - Ft. Lewis
- 2 – Ft. Sill

Avn Bdes (11)

- Ft. Bliss
- Ft. Bragg
- Ft. Campbell (2)
- Ft. Drum
- Ft. Hood
- Ft. Riley
- Ft. Stewart (HAAF)
- Germany
- Hawaii
- Korea

Red is a part of Grow the Army - GTA





RC AMMUNITION UNITS



- 1 Ammo Group:
 - 303 Ord Group, Springfield, IL
- 4 Ord Bn:
 - 125th Ord Bn, Billings, MT
 - 320th Ord Bn, Lincoln, NE
 - 321st Ord Bn, Cross Lane, WV
 - 322nd Ord Bn, Kenova, WV
- 13 Ord Ammo Co.
 - 163rd Ord Co, Santa Ana, CA (HQ, HLP & MLP)
 - 221st Ord Co, Ft. Wayne, IN (HQ, HLP & MLP)
 - 261st Ord Co, Cross Lane, WV (HQ, HLP & MLP)
 - 266th Ord Co, Aguadilla, PR (HQ, HLP, MLP)
 - 295th Ord Co, Hasting, NE (HQ, HLP & MLP)
 - 351st Ord Co, Romney, WV (HQ, HLP & MLP)
 - 395th Ord Co, Appleton, WI (HQ, HLP & MLP)
 - 452nd Ord Co, Aberdeen, SD (HQ, HLP & MLP)
 - 592nd Ord Co, Billings, MT (HQ & MLP)
 - 802nd Ord Co, Gainesville, GA (HQ & MLP)
 - 811st Ord Co, Rainelle, WV (HQ, HLP & MLP)
 - 826th Ord Co, Madison, WI (HQ, HLP & MLP)
 - 962nd Ord Co, Plattsburg, NY (HQ & MLP)



Transformation - Arm

From

- Modular Ammo CO HQs and PLTs, BNs and Groups based on geographical support using supply point logistics
- Reliance on other echelons for support
- Corps provided ASP and storage areas in Division AO

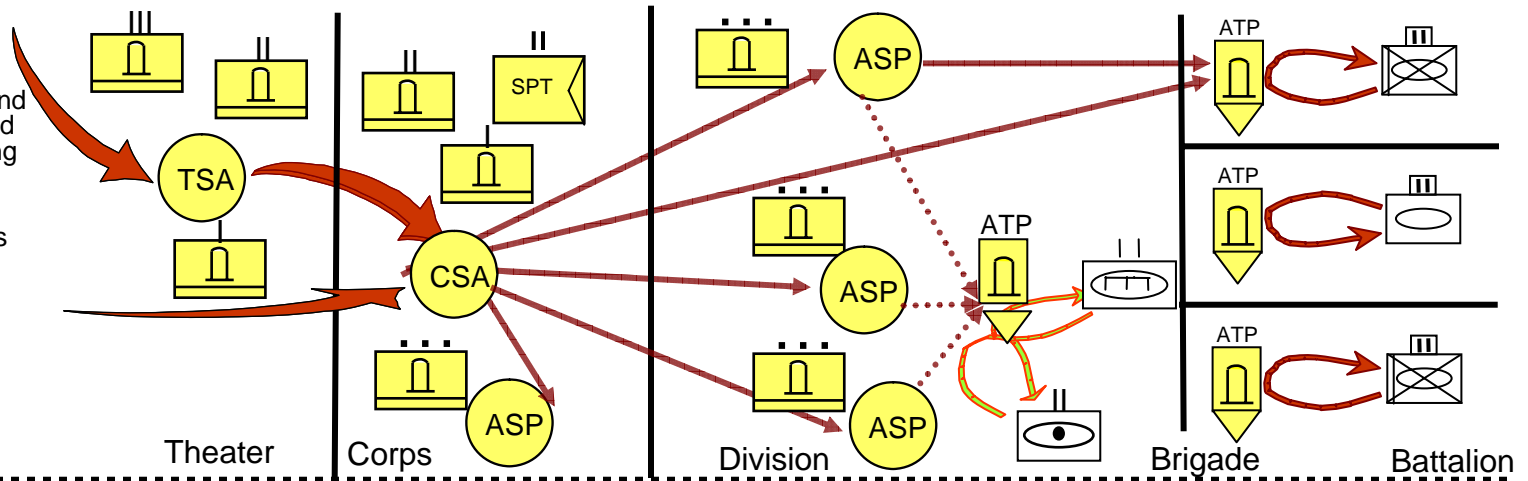

TO

- Modular Ammo CO HQs and PLTs, BNs based on METT-TC
- Tailored configured loads delivered forward in the battle space
- Supports Mission Staging Operations (MSO)
- TSC / ESC
- - Receive, store, issue and reconfigure Configured loads (CL) and build Mission Configured Loads (MCL)
 - Maintain, manage, theater level stockages
 - Support theater opening
 - SAAS-MMC in SUS DMC for AMMO management
- Div / Corps
 - limited reconfiguration of MCLs and reconfigures and redistributed retrograde
 - METT-TC organized with mix of Med and Hvy PLTs
- BCT / Bdes
 - Embedded Ammo management function (SAAS-DAO)
 - Brigade organic 13 soldier ATHP design allows for munitions accountability and limited storage (SAAS-ASP)
 - Distro platoons and companies distribute to unit level
 - Limited ability to reconfigure loads

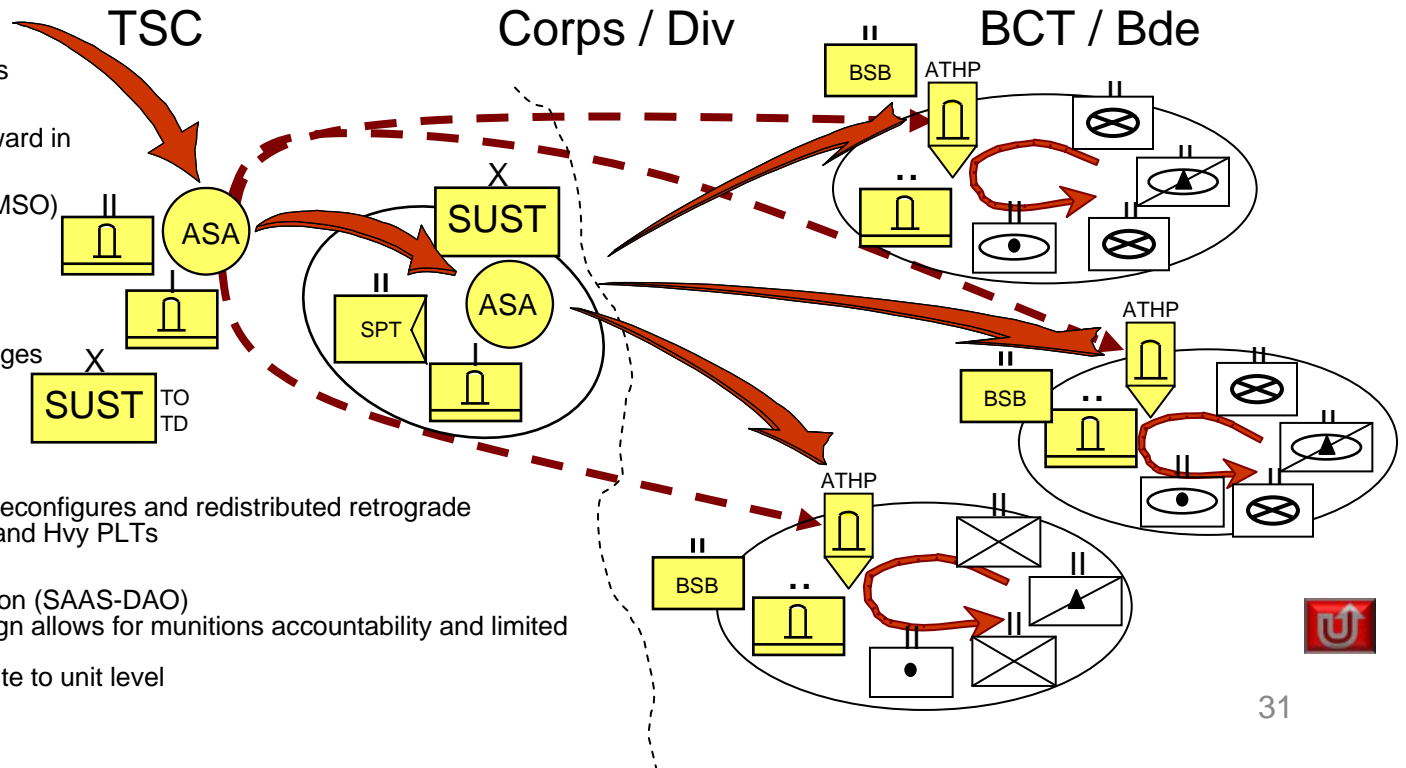

OK...What's Different at MY BDE Level – AOE vs BCT?

Personnel - 6		Equip	Mission	Capabilities
<u>From</u>	E-6 89B	SAAS – ATP	Provide ammo spt to Bde sector.	“Transfer Point”
DIV	E-5 89B	PLS TRK x 3	Receives mission guidance/ priorities from DAO .	PLS Flatrack Exch or transload ammo stocks from corps trucks to combat unit trucks.
ATP	E-4 89B x 2	PLS TRL x 3		
	E-3 89B x 2	RTFL x 2		
89B - Ammo Specialist			<u>AOE Division</u> managed/ distributed ammo to bdes	
Personnel - 13		Equip	Mission	Capabilities
<u>TO</u>	WO2 890A	SAAS – ATHP	Provide ammo spt to BCT. Receives mission guidance and priorities from BAO .	“Mini-ASP”
BCT	E-6 89B	MTS		Receive, store, Issue, acct for Bde ammo stocks
ATHP	E-5 89A*	PLS TRK x 3		Limited inspection and maint of CL V Stocks.
	E-5 89B x 2	PLS TRL x 3		REC/ISS 62 STONS
	E-4 89A*	TRK CGO x 1		STORE 14 STONS
	E-4 89B x 4	RTFL x 2		SURGE 138 STONS
	E-3 89B x 3		<u>BCT</u> manages, accounts for, and distributes its ammunition	
*89A - Ammo Stock Records and Acct Spec – New MOS				

Ordnance Enlisted Training & Development Model

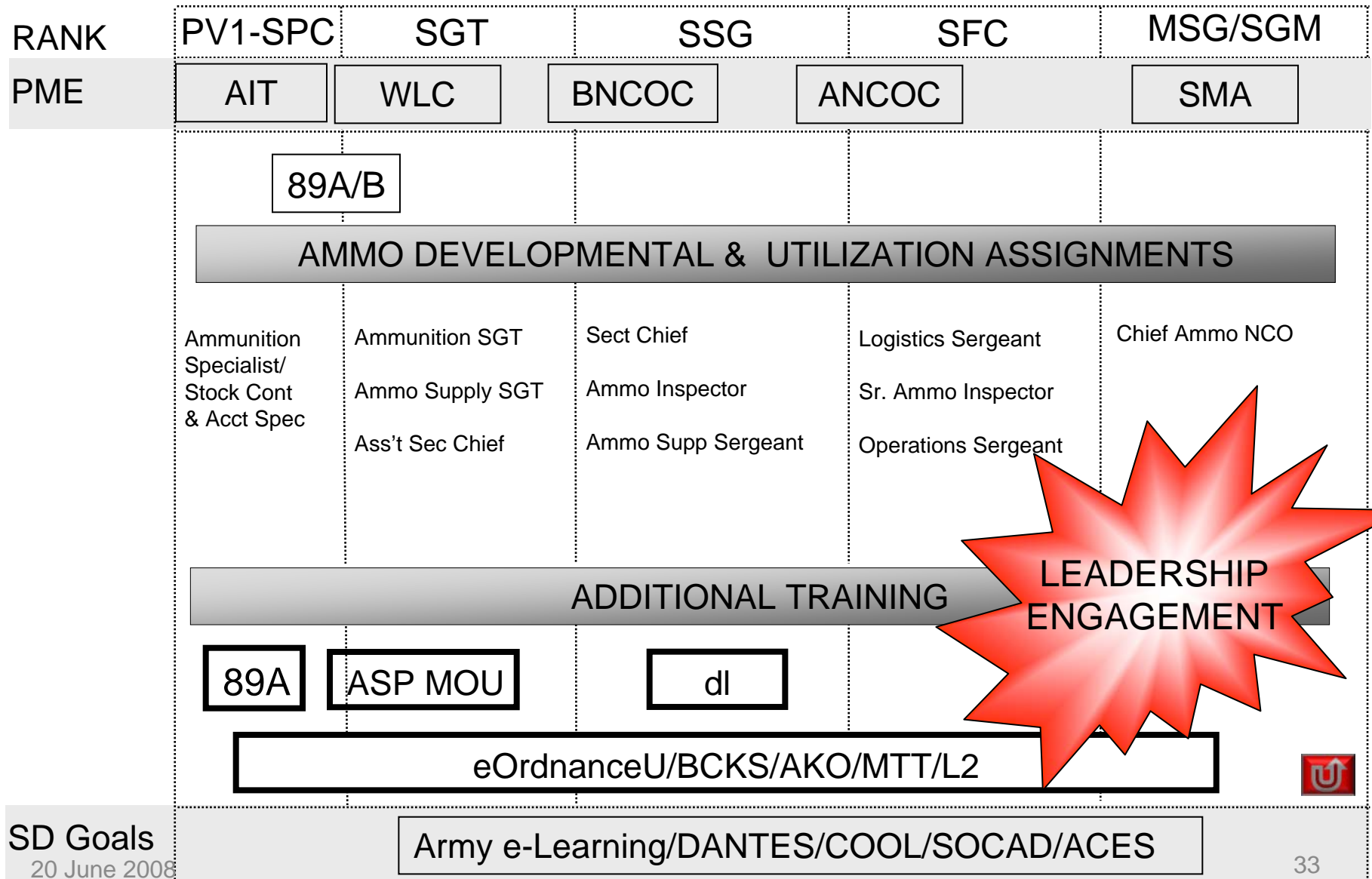

Warrant Officer Training & Development Model

RANK	WO1	CW2	CW3	CW4	CW5
PME	WOBC		WOAC	SWOC	SWOSC
AMMO DEVELOPMENTAL & UTILIZATION ASSIGNMENTS					
	BSB ATHP Accountable Off MOD Ammo PL/CO	Advisor Instructor/ Writer Distro Management Center (DMC) (SB/ESC/TSC)	Advisor Instructor/ Writer DMC (ESC/TSC) TNG/Combat Developer Combat Readiness Ctr		Sr. Advisor/Manager (ASCC/Joint Command) DA (G-3/G-4)
ADDITIONAL TRAINING					
	↑ WOBC SL				
	eOrdnanceU/BCKS/AKO/L2				
SD Goals	Baccalaureate Degree/Professional Cert				
20 June 2008				Graduate Studies/Professional Certification	

Ordnance Officer Training & Development Model

