



LIGHTWEIGHT AMMUNITION DESIGN - 8550

Kevin Brown, VP Government Relations, Colt Defense LLC

Vincent Battaglia, VP Operations, BML Tool & Mfg. Corp

National Small Arms Conference - 9610

Las Vegas, Nevada

20 May 2009



Introduction



- NSAC Contract Award
- Colt / BML teaming relationship
 - Colt Defense is a leading designer, developer and manufacturer of small arms and weapons systems for the U.S. Military, its allies and federal, state and local law enforcement agencies.
 - B.M.L. Tool & Mfg. Corp. has been serving the Metal Stamping industry for over thirty years with critical application tooling and parts and offers full engineering services for all needs including tool & die design as well as product design.
- Introduction of nontraditional suppliers
- Introduction of speaker

Overview

- Purpose of presentation
- Modular case concept
- Prior art
- Patents pending
- Development of alternatives
- Project growth
- Future efforts

Agenda

- Problems with current ammo
- Casing technology improvements
 - Modular case
 - Spiral case
- Benefits
- Next steps

Change is needed in ammo manufacturing

- Develop sub component to fast assembly systems and process
- Target goal:
 - 80% sub component
 - 20% live ammunition
- Dramatic culture change required to modernize current ammunition manufacturing activities.
- New Standards and Specifications need to be developed.



Design & development objectives

- Create manufacturing systems to allow JIT manufacturing.
- Partial mitigation of yearly “LIVE AMMO” supply through sub-component stock pile and “AS NEEDED” assembly.
- Consider GREEN components in both casing and Projectile materials.
- Reduce weight! Ammo is in top 4 of items (by weight) carried by the individual soldier/Marine.
- Scale: develop manufacturing systems for small arms through mid cannon caliber ammunition (5.56mm – 40mm).
- Need to recognize fiscal realities, costs need to deflate while capabilities inflate.

Specific problems with casings

- Brass has many positive aspects:
 - Heat transfer/extraction
 - Elasticity
 - Strength
- But there are negatives:
 - Weight (firepower)
 - Cost
 - Corrosion



Two design solutions to casing problems

- MODULAR CASE
 - Hybrid Steel/Polymer System for 50BMG and larger munitions.
 - Can replace any conventional steel or brass bottle neck case.
- SPIRAL CASE
 - All-polymer molded case in two parts Case Body and Rim Base.
 - Primary use for 5.56 through 50BMG small arms ammunition

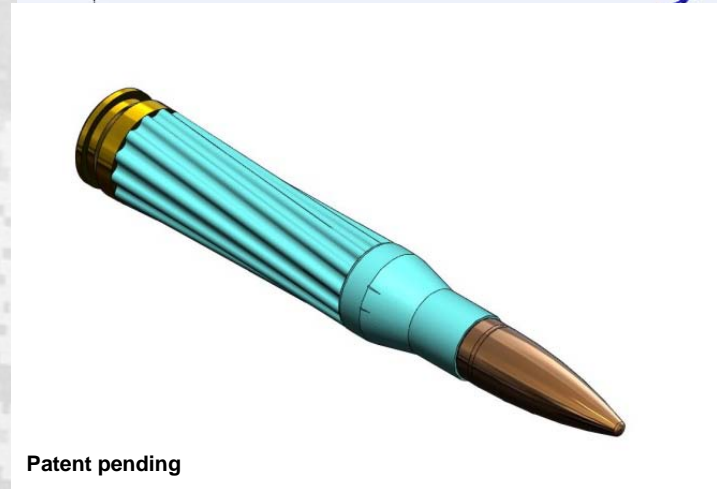
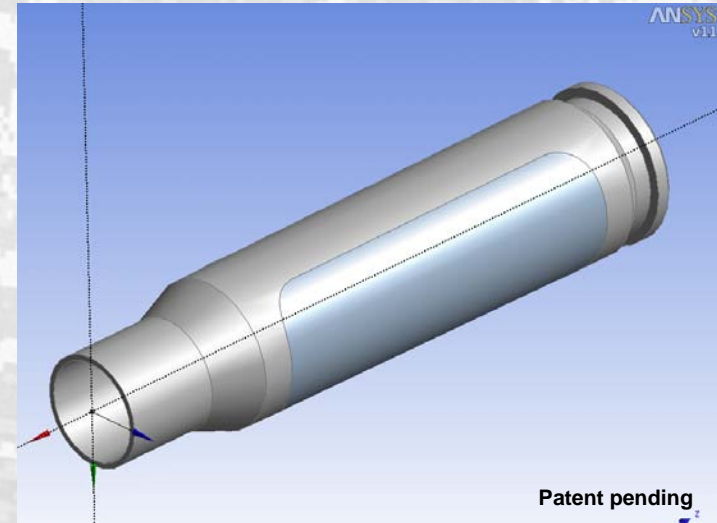

Modular case

- Variant Polymer/Steel design for 50CAL through 40MM.
- Skeleton Case Metal stamping with insert molded charge vessel.
- Good weight savings in large cases.
- Very strong hoop strength.
- Modular Manufacturing for JIT or SCAMP.

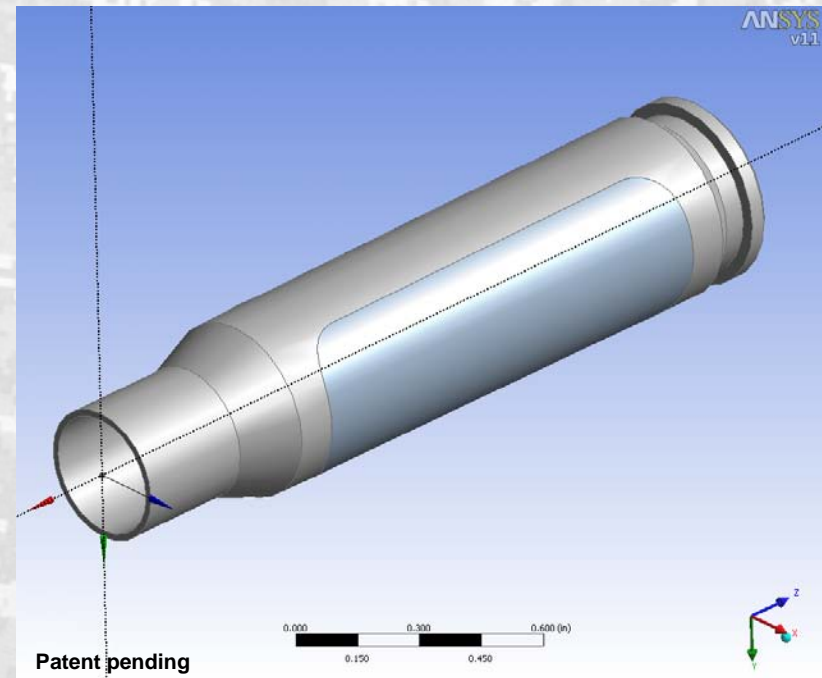

Separate the case from the powder!

- Skelton case portion
 - A determined progressive metal stamping of two drawn target areas rotated to a common centerline.
- Charge vessel
 - Propellant storage to charge weight, purged, covered.
 - Stored as sub-component.
- Assembly of Charge Vessel
 - dynamically inserted into the “Skeleton Case” followed by Primer for a “Live Round”.

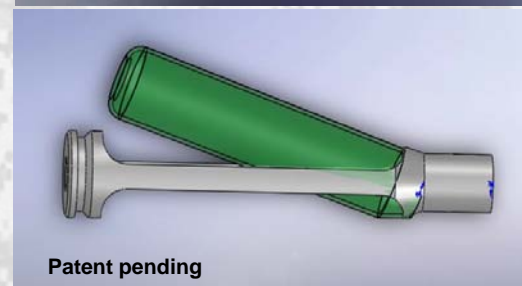
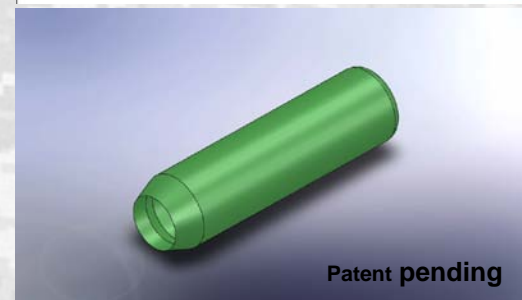
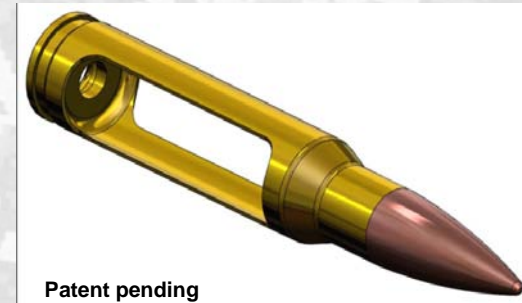

2nd variant, insert molded

- Second mode of manufacturing with “CHARGE VESSEL” as integral insert molded operation.
- The insert molded “Charge Vessel” allows the variant case to be assembled in conventional manner.

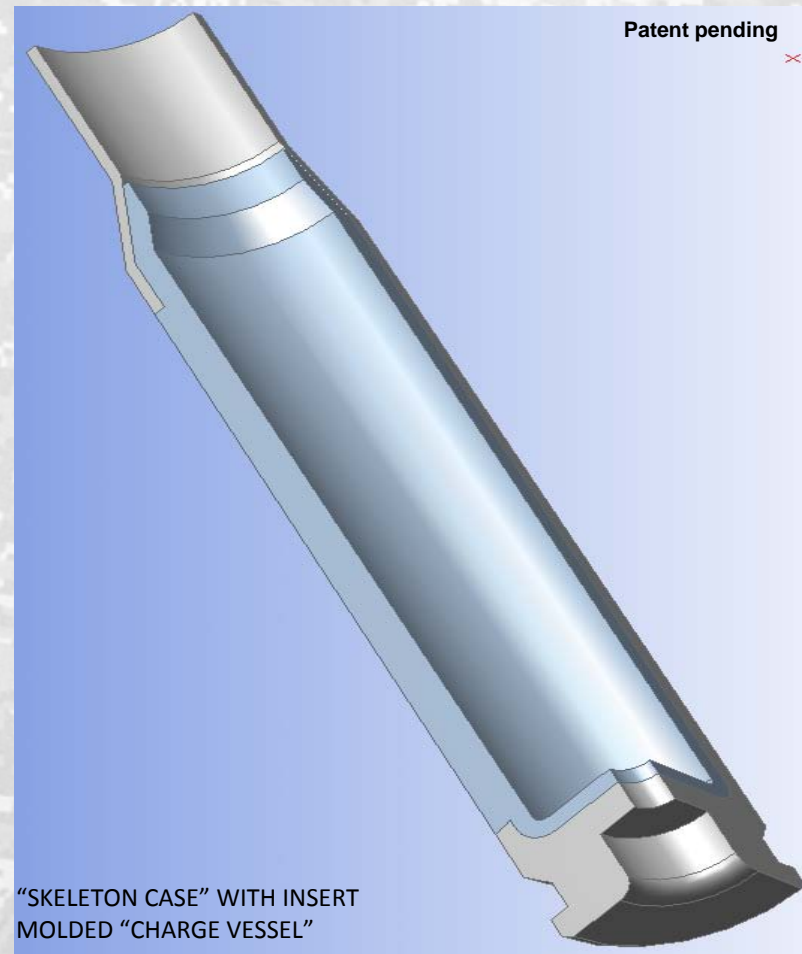

Spiral polymer case

- Benefits
 - Spiral Ribbing enhances “hoop strength”
 - eliminates “heat transfer”
 - reduces “extraction friction by 70%.”
- Manufacturing process allows for conventional bullet insertion in the SCAMP line or can be insert molded with the case.

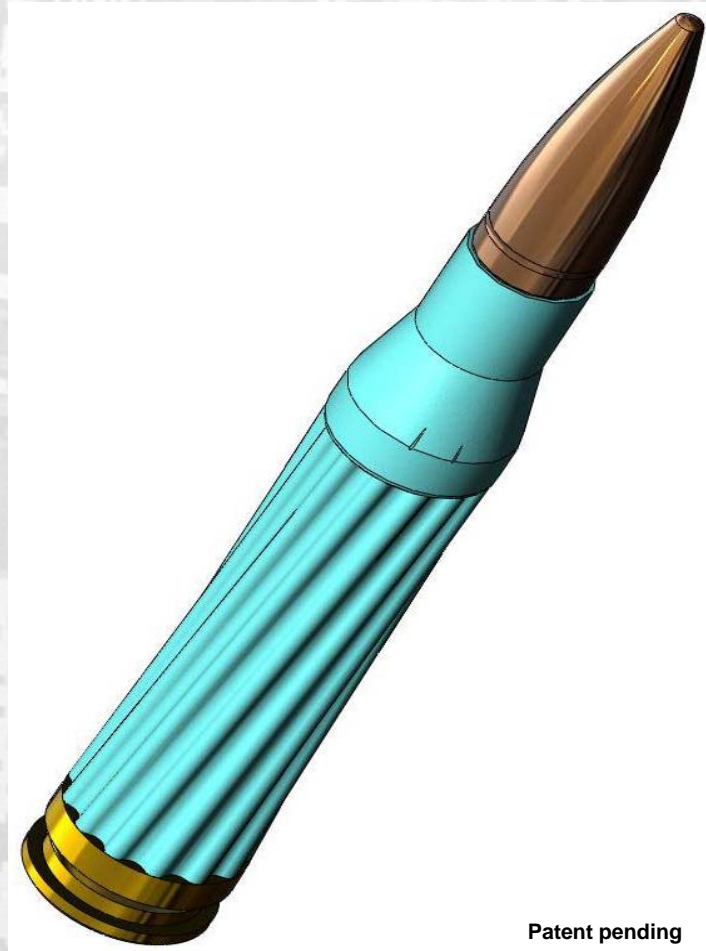

Patent pending

Benefits at the prototype stage

- Charge weight measurement within 5% of conventional 50BMG.
- Case weight savings of 47% over Brass.
- .091 lbs per round weight savings in 50BMG.

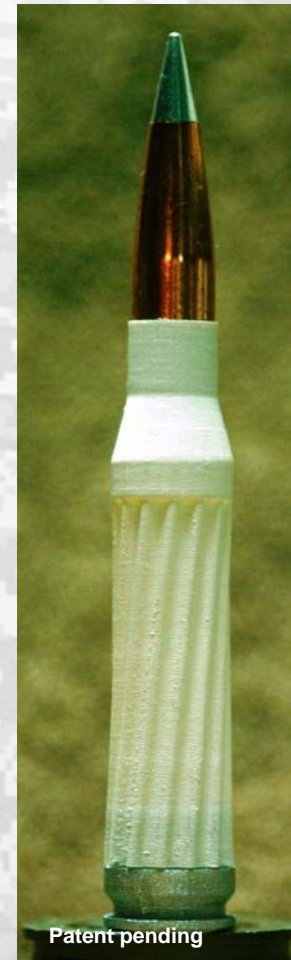
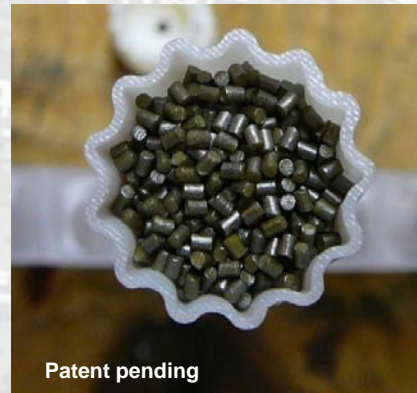

Other spiral case features

- RIM/BASE COMPONENT
 - This is a molded component with an insert stamping internal in the shape of an “H”, the bottom houses the primer with the flash hole pierced out and the top portion acts as a blast tray for ignition.
- ASSEMBLY & BONDING
 - Ribbed Perimeter adds approximately 50% more perimeter for bonding and joint strength.
 - Helical Twist of ribbing mitigates pressure force line at ignition. Also aids in the extraction sequence from the weapon.

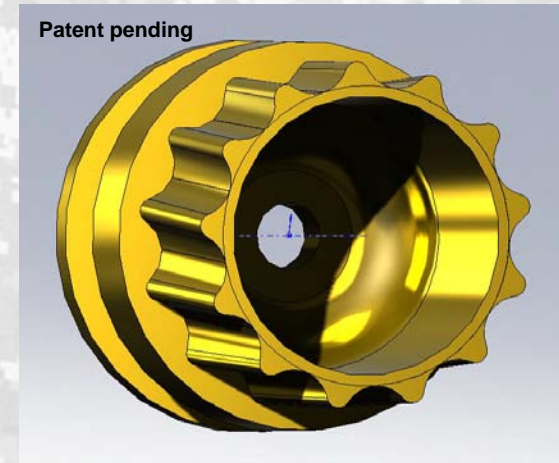



Manufacturing benefits



- Can be manufactured as a conventional case by bonding the rim/base to the case for conventional processes.
- Projectile can be insert molded to the case for a back fill technique.
- Modularity allows JIT and stock pile of components.
- NOT “LIVE” Ammunition.

Summary of attributes/benefits

		
	Modular Case	Spiral Case
Best application	50 BMG – 40 mm	5.56mm – 50 BMG
Case weight saving	20-25%	40-47%
Strength	Equivalent	Equivalent
Modular manufacturing	YES	YES
Case cost reduction	~15%	0-8%

Next steps

- Complete all product and process designs.
 - Tool design and prototyping on going in early phases.
- Establish commercial partnerships with critical path vendors.
- Live fire testing at earliest opportunity.

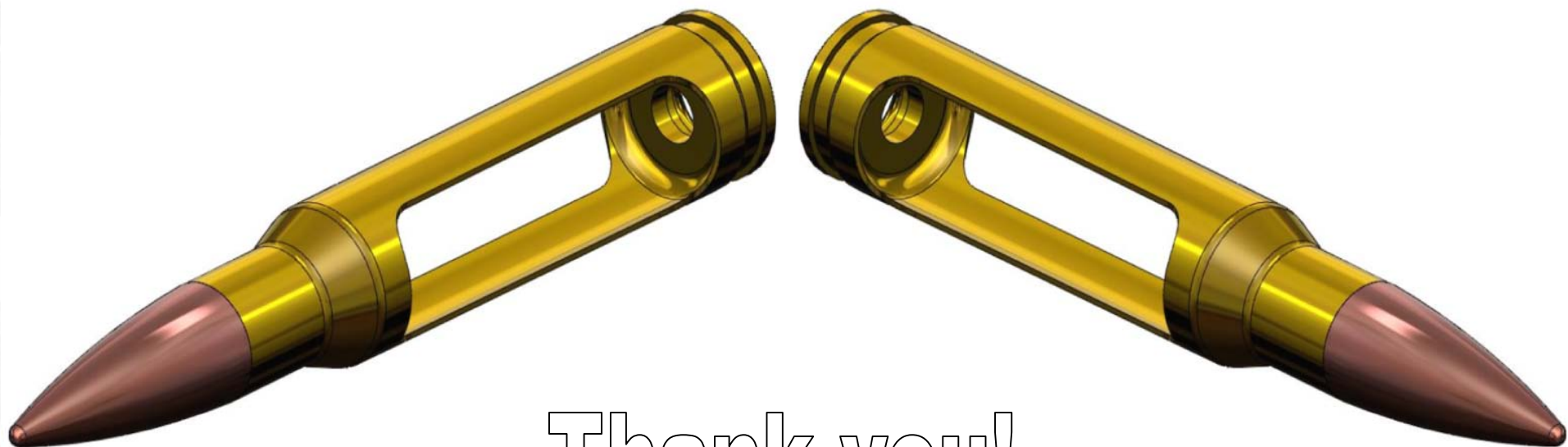

Thank you!



Patent pending