

# GRIDLESS POWER

Joint Services Power Expo 2015

Reducing Logistical Burden  
and Increasing Capabilities through

## Nanogrids





# GRIDLESS POWER

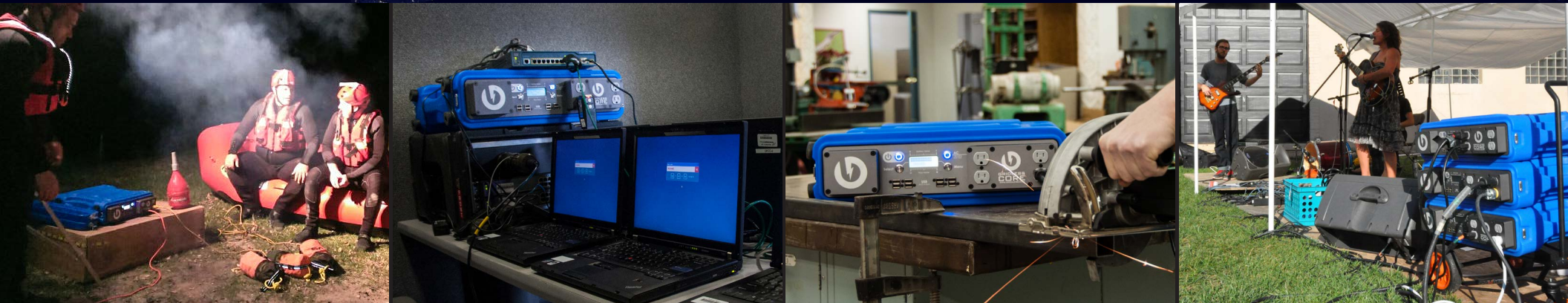

- Nanogrids introduction
- Nanogrids in action
- Connected power

**Traditional Power Sources**

**Renewable Power Sources**

**Grid**

**Electrical Loads**

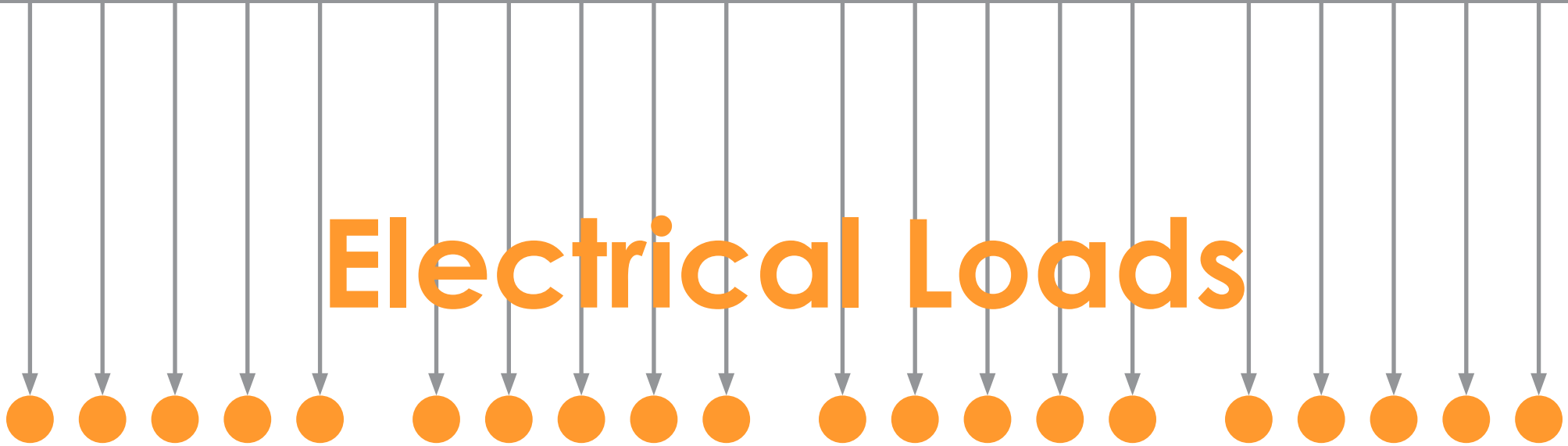



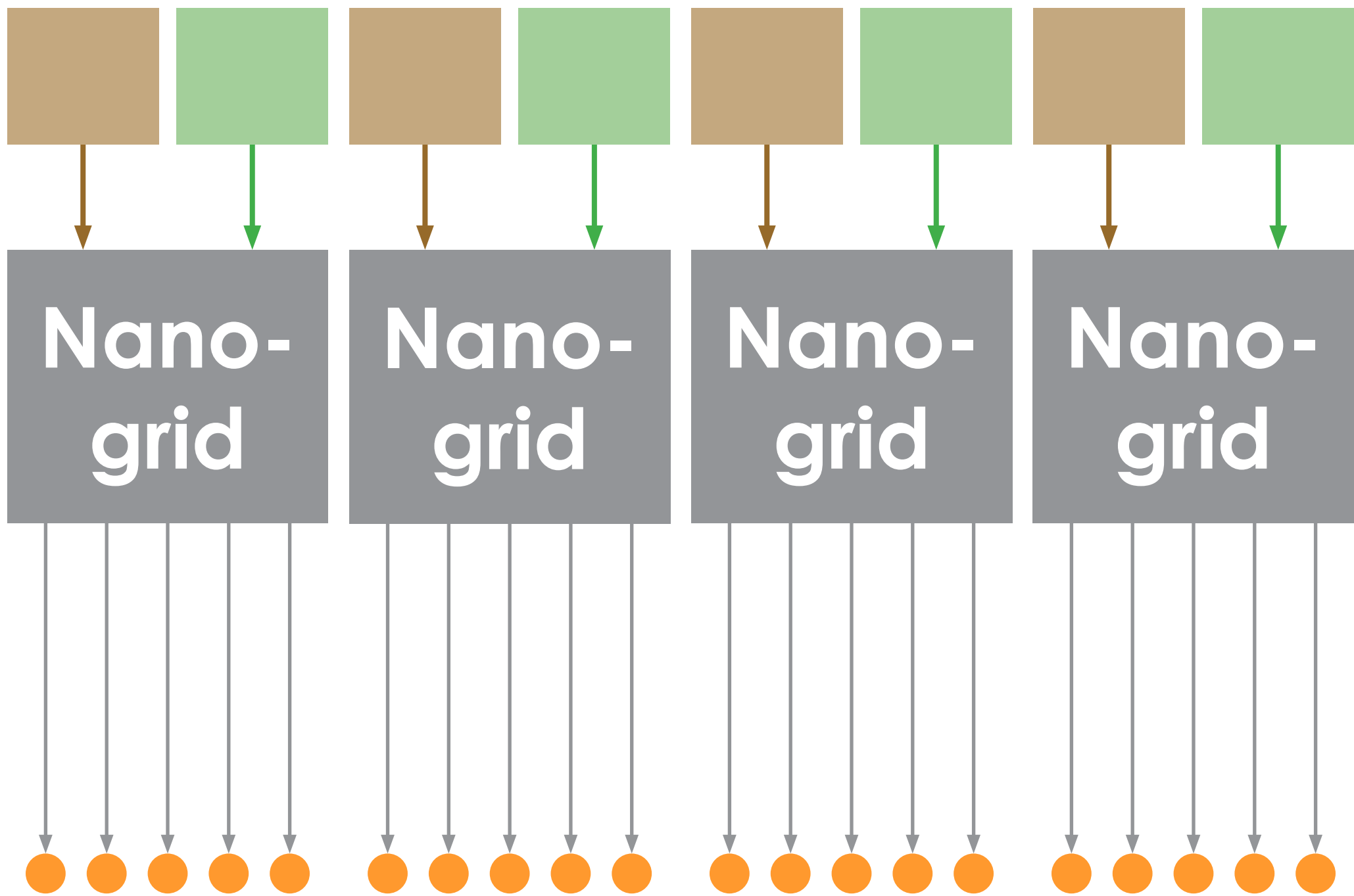

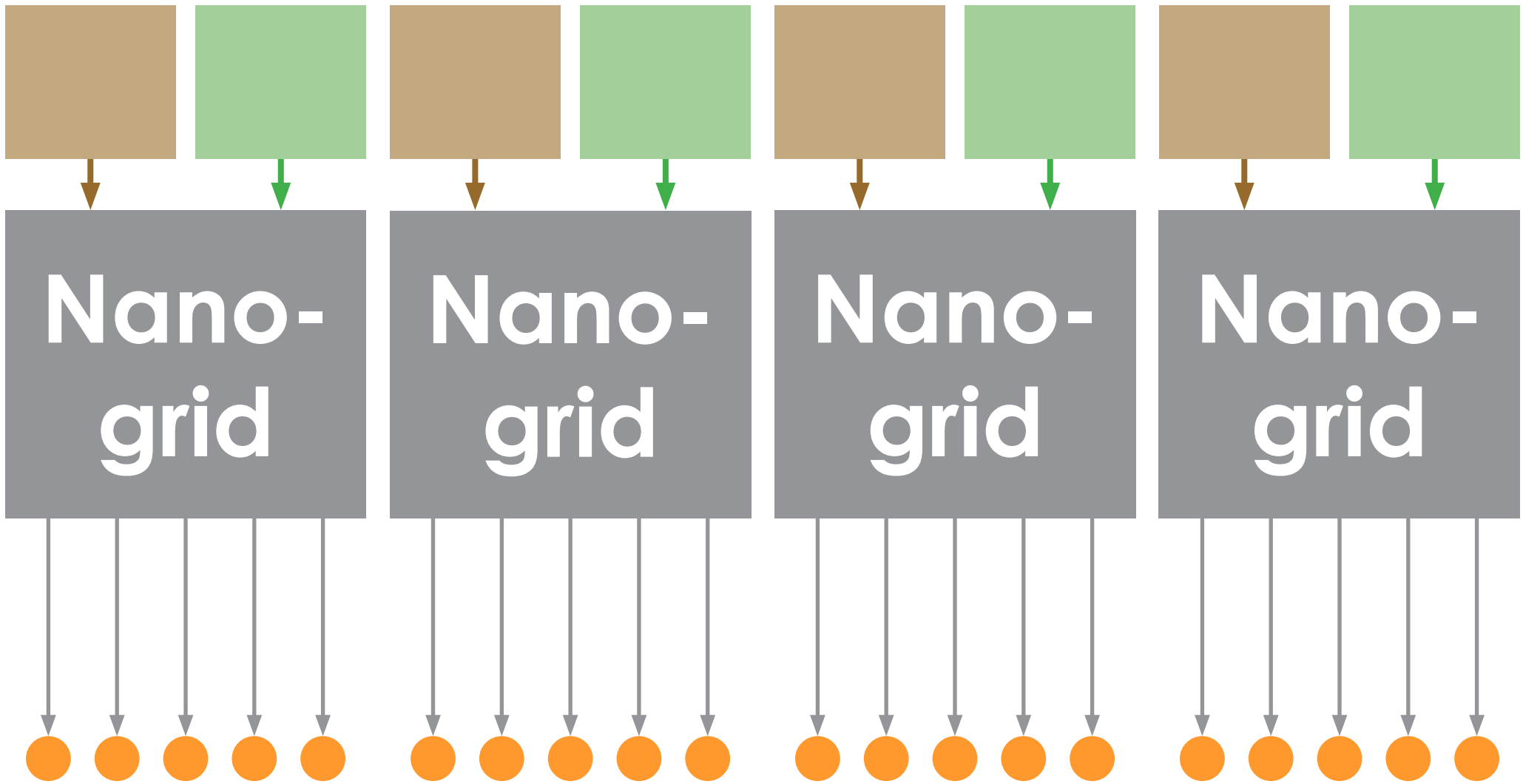

Cellphones



Tablets



Radios



Laptops

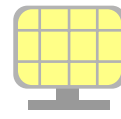

Lighting



Power-tools

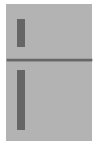

Refrigeration

# Microgrid

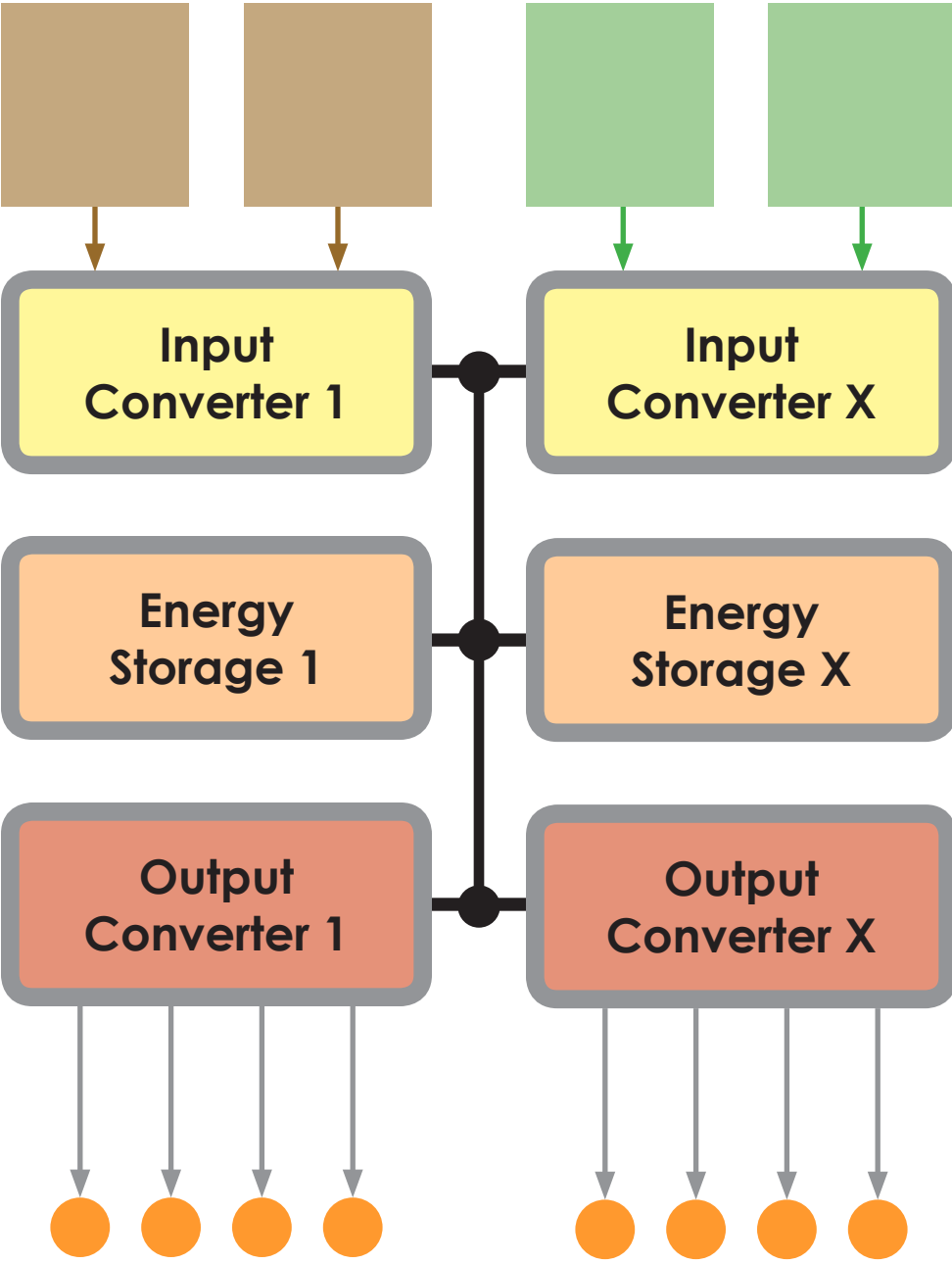

# Nanogrid

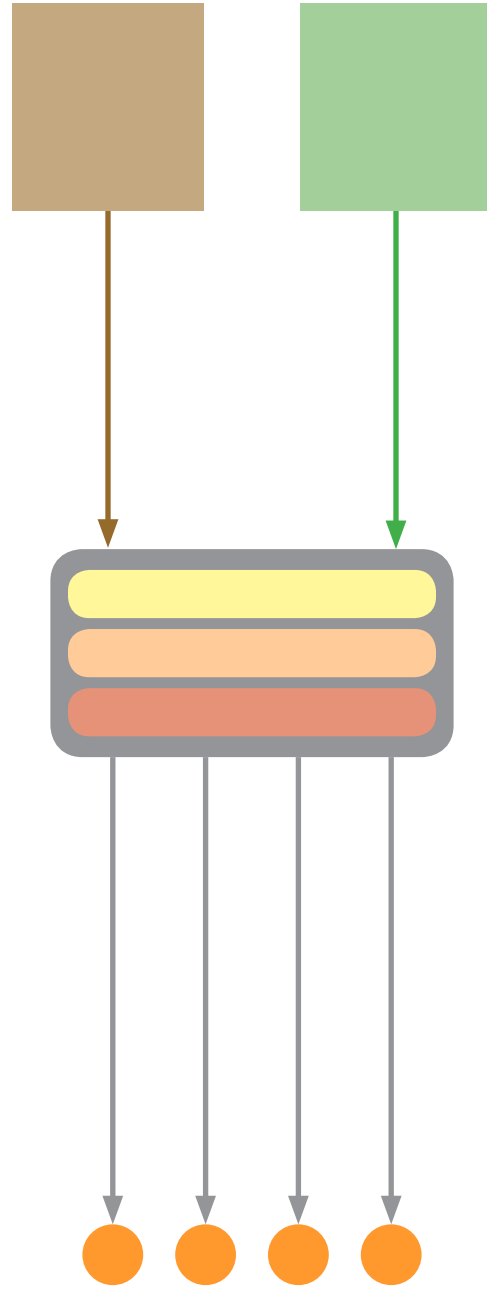



# Microgrid

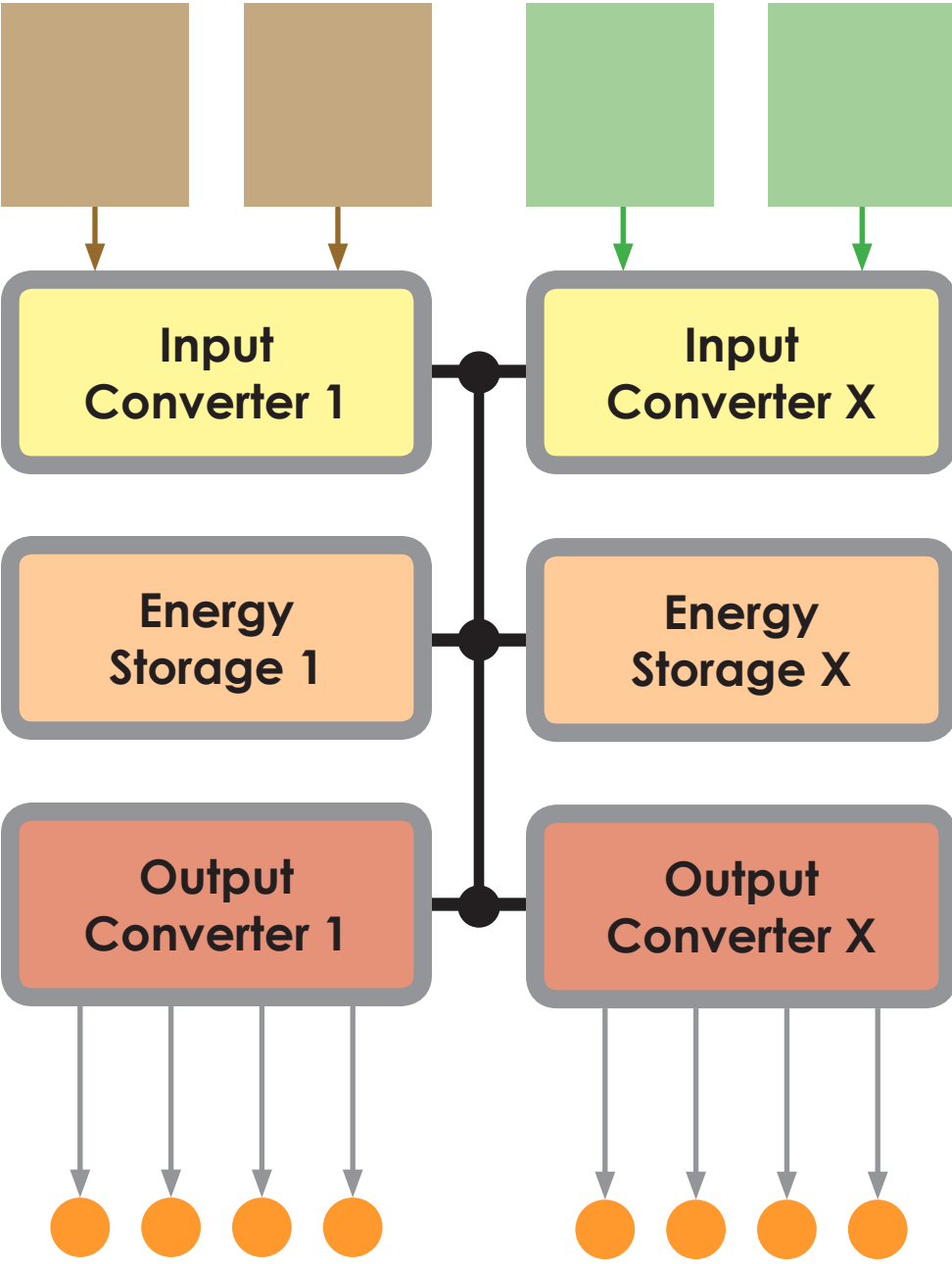

# Nanogrid



# Gridless CORE



Use it



Move it



Charge it



Track it

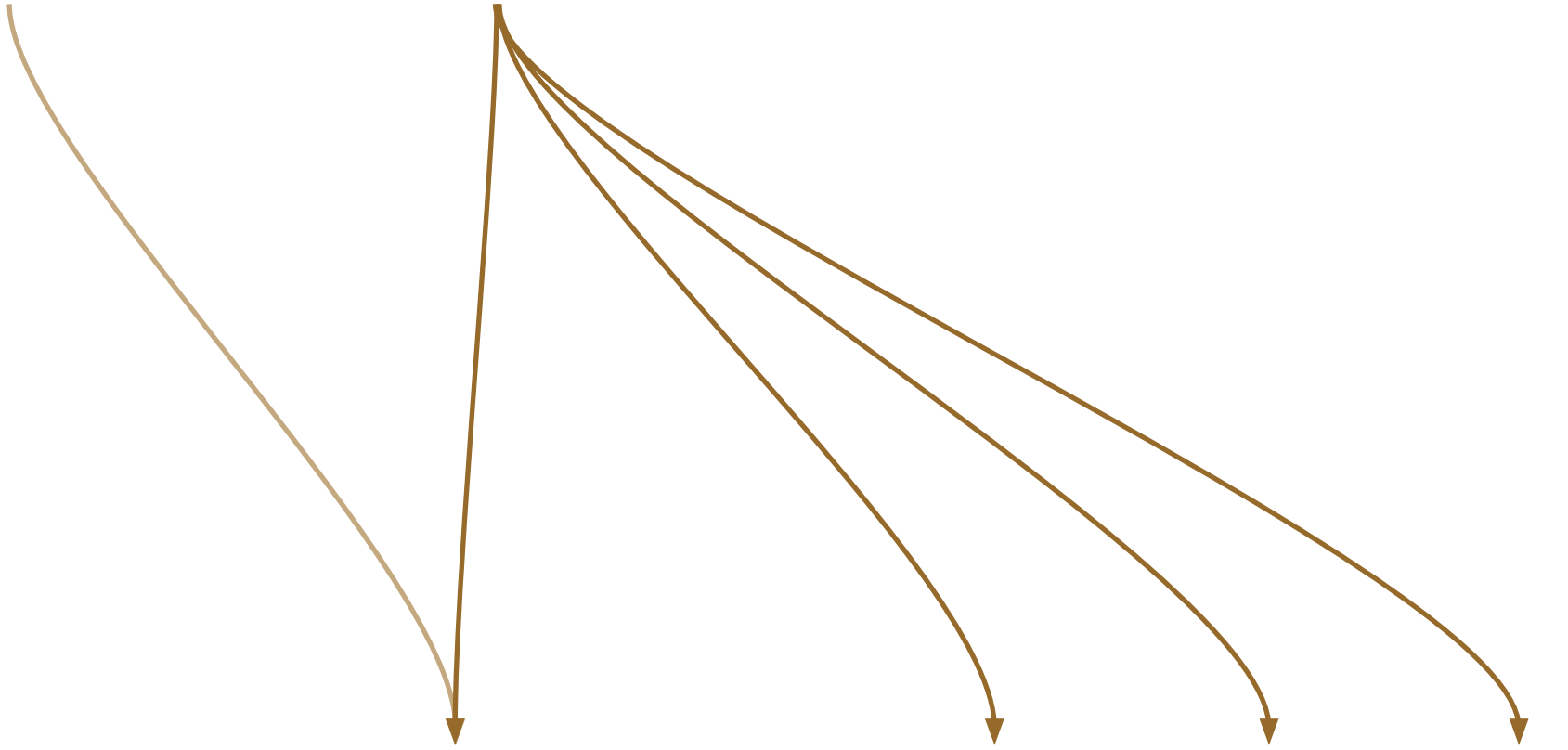
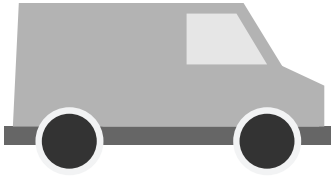

**Radios**

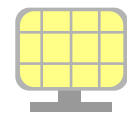

**Lighting**



**Power-tools**

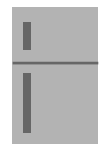

**Refrigeration**

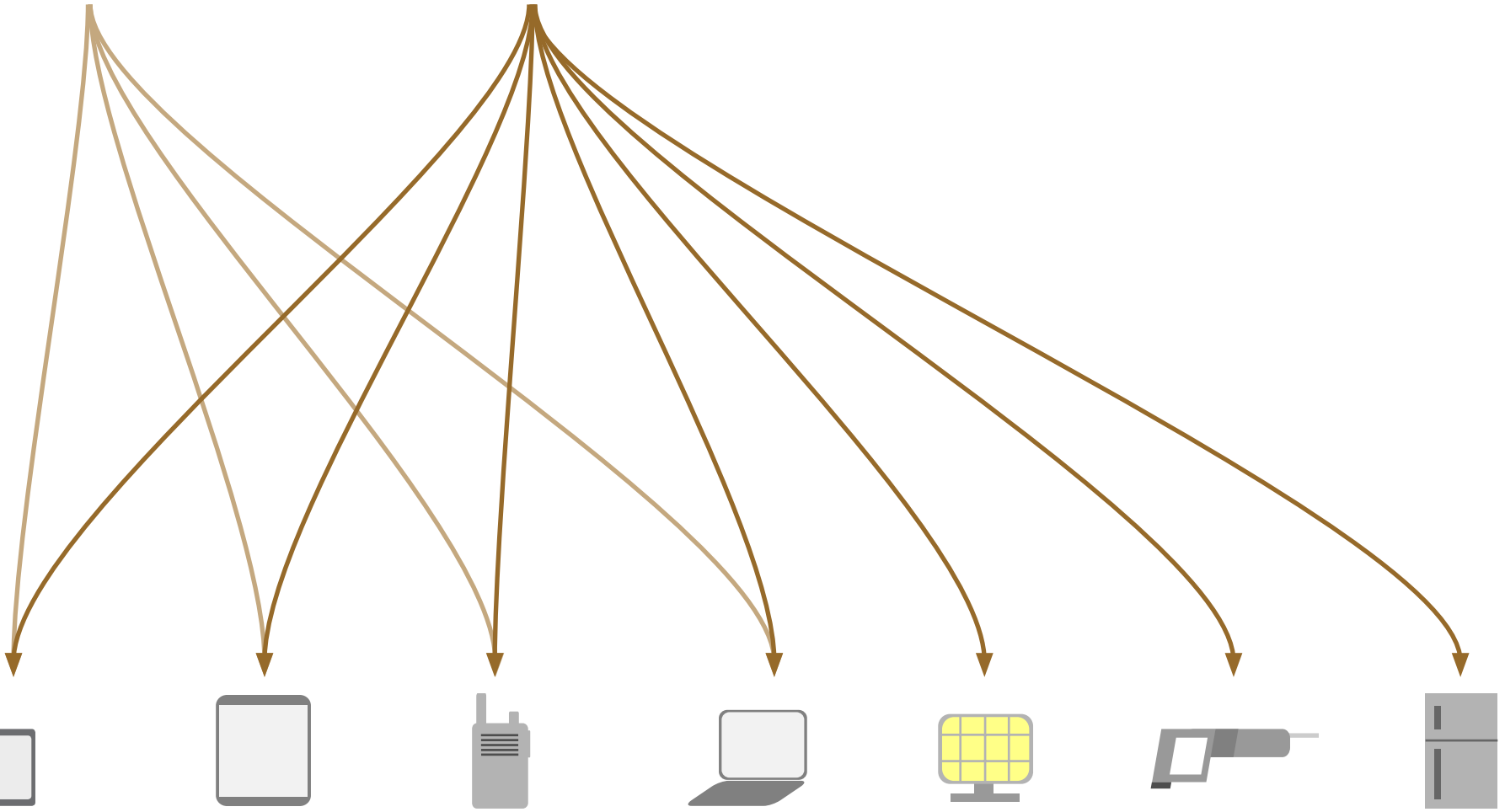
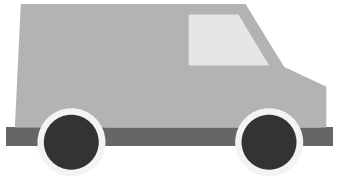

Cellphones

Tablets

Radios

Laptops

Lighting

Power tools

Refrigeration

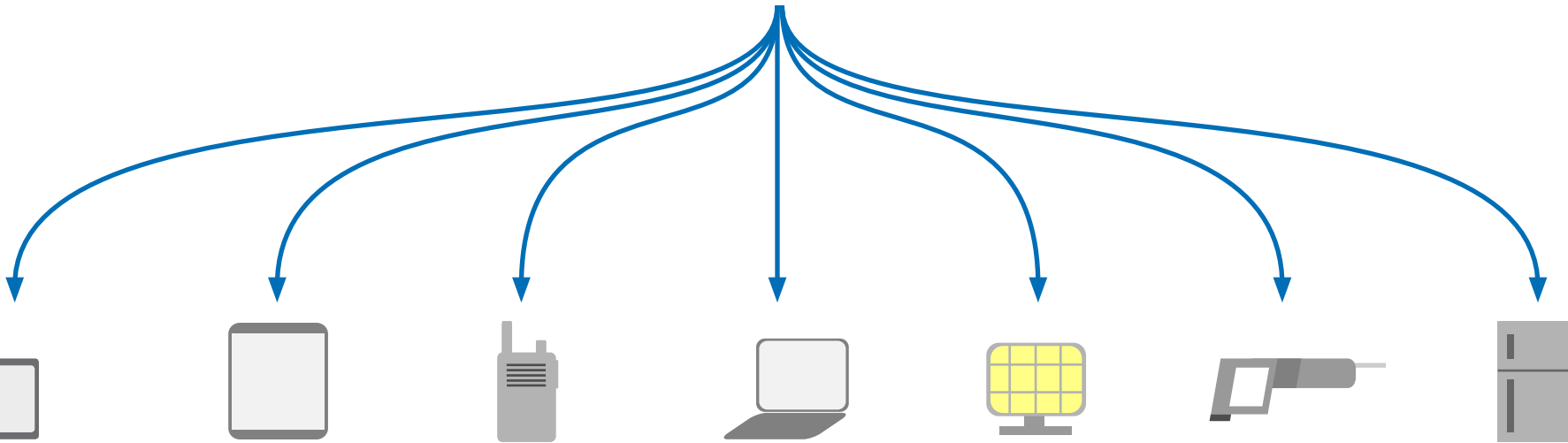
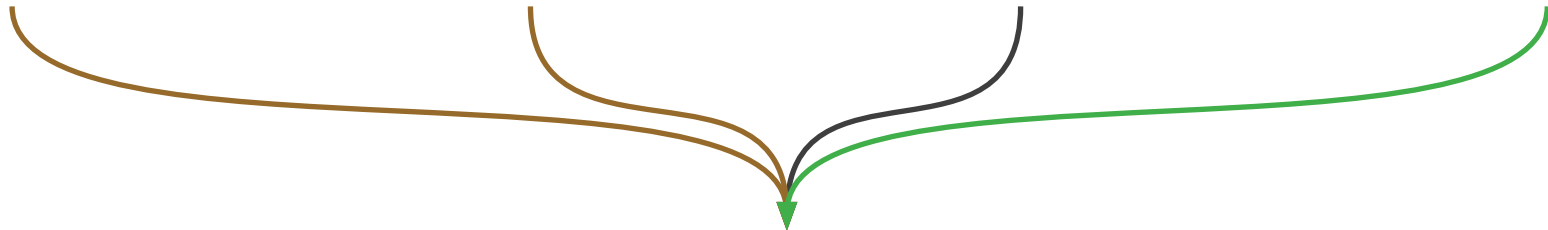
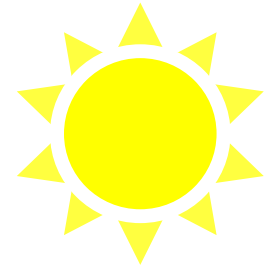
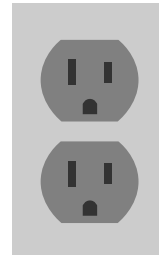
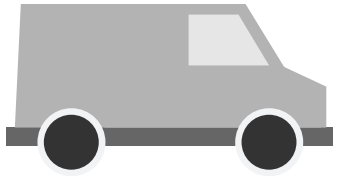

Cellphones

Tablets

Radios

Laptops

Lighting

Power-tools

Refrigeration

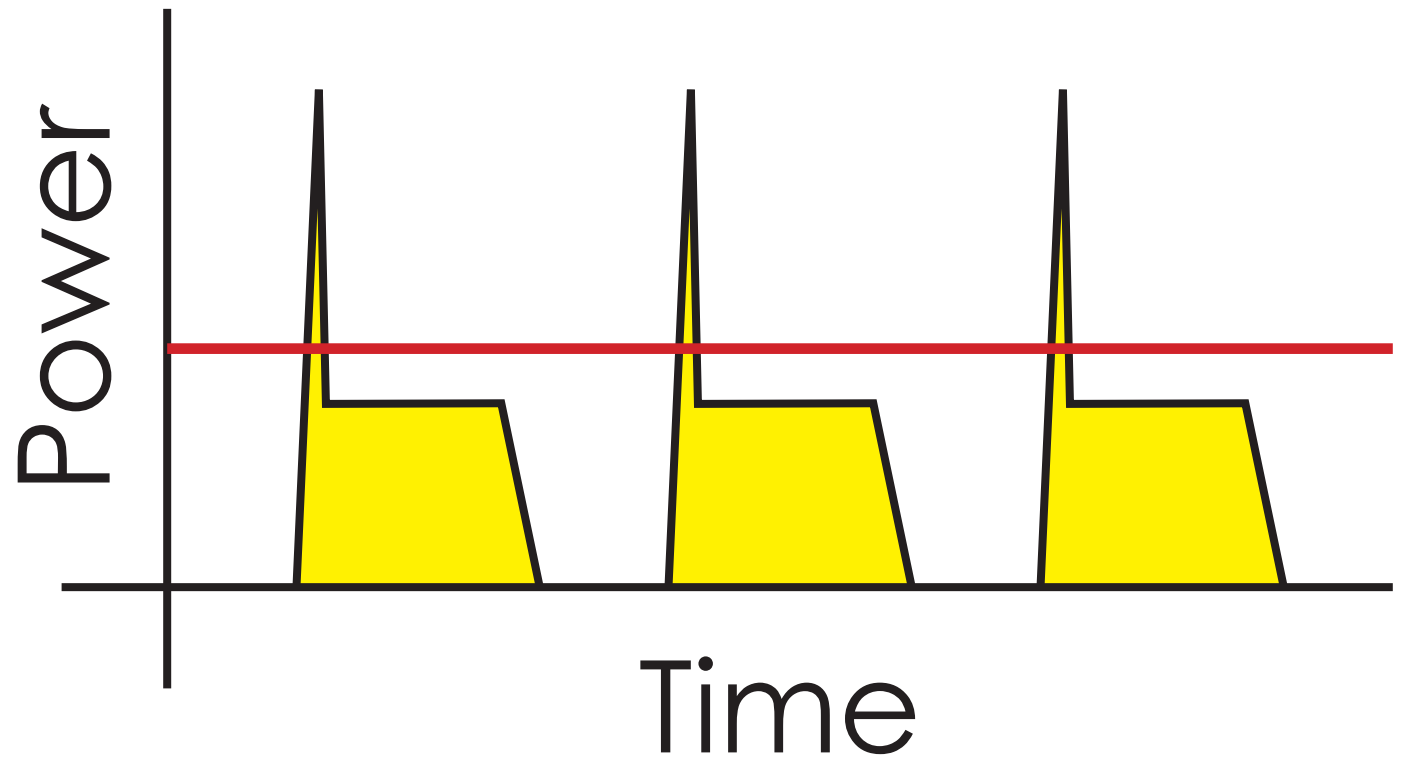
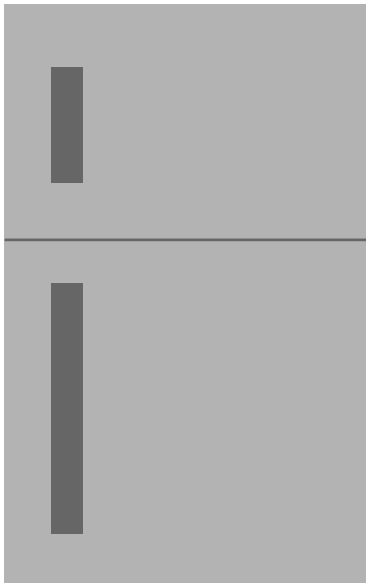

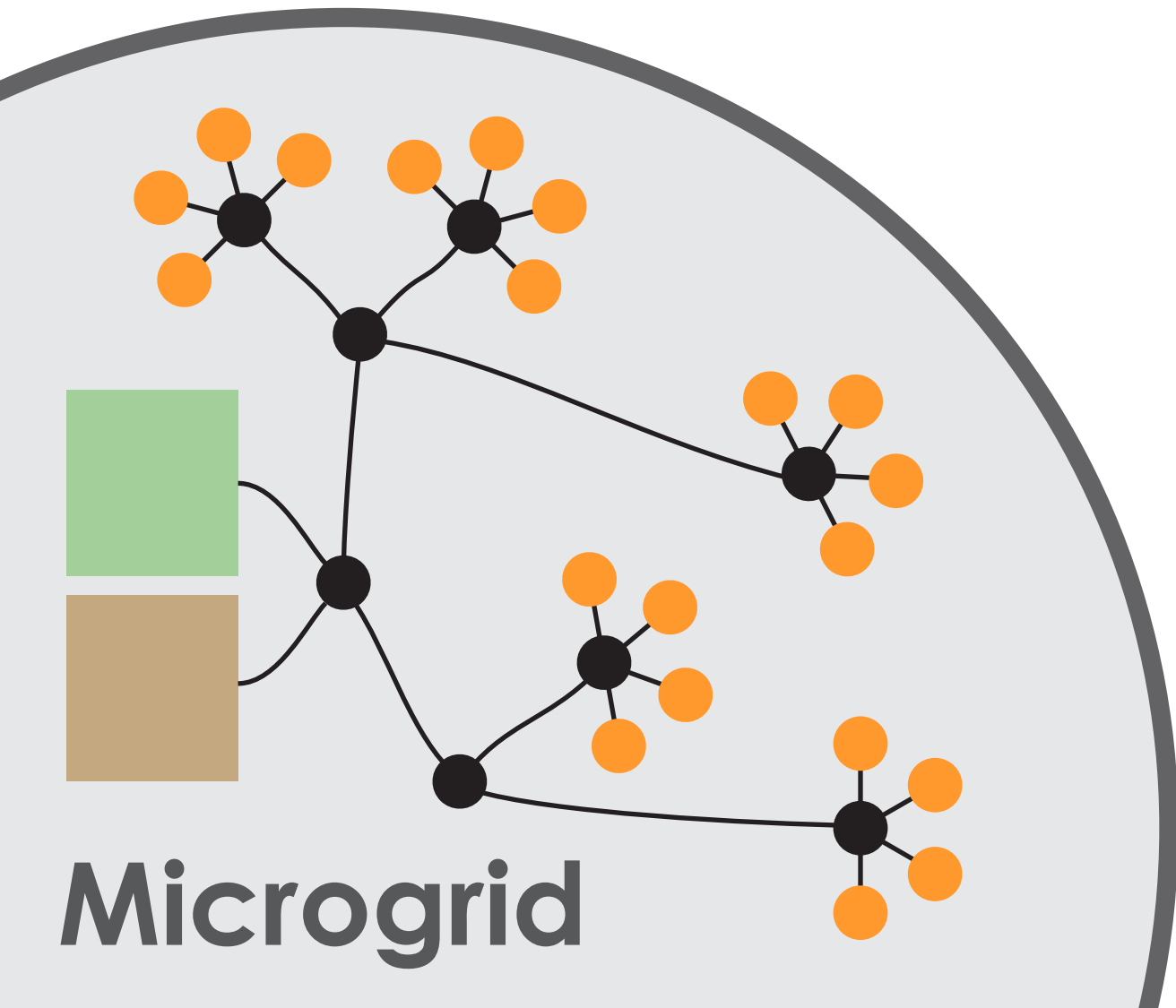

**Microgrid**

# 1. Outside the Microgrid

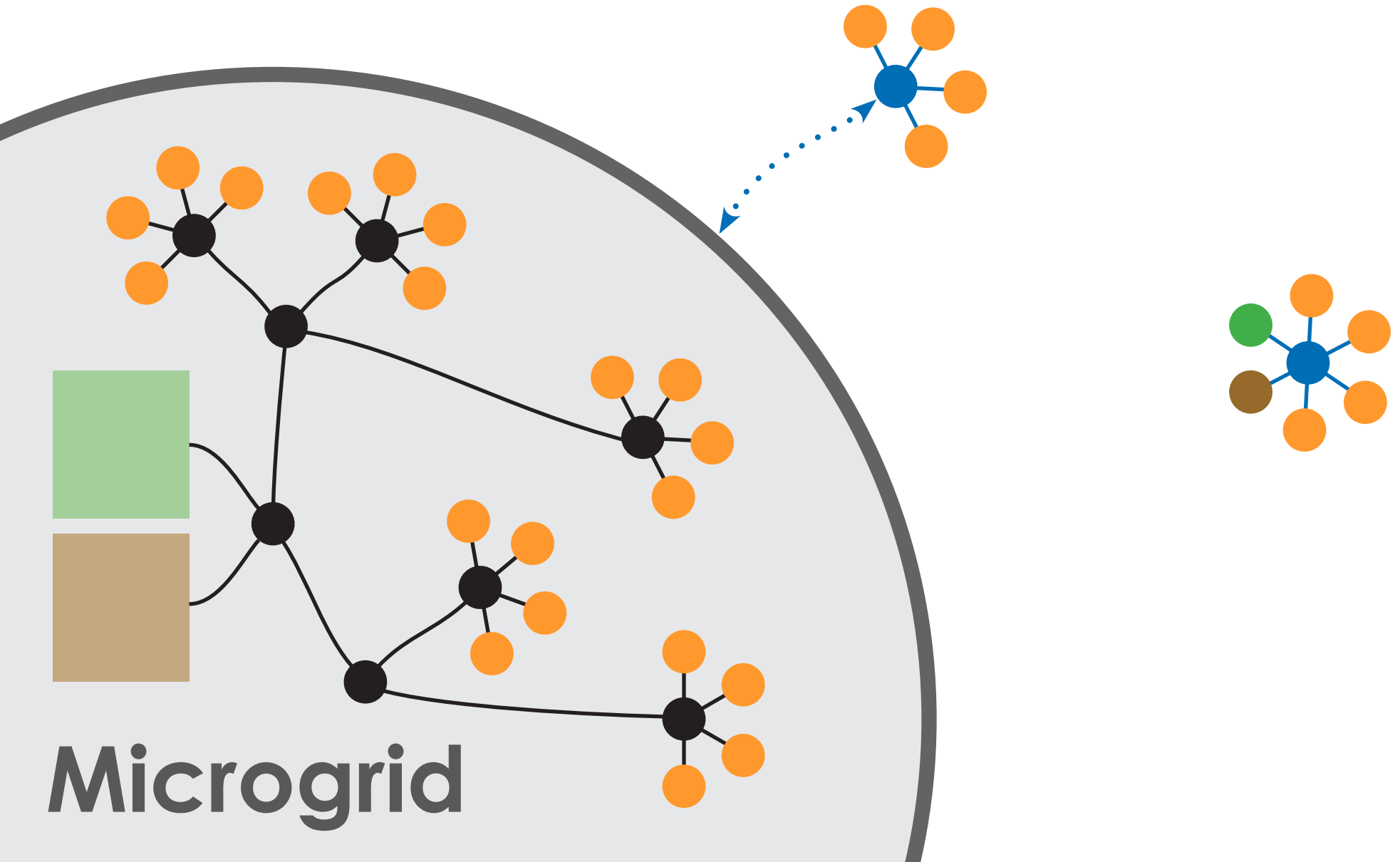







EvoSafe 4  
Safety Box





# 1. Outside the Microgrid

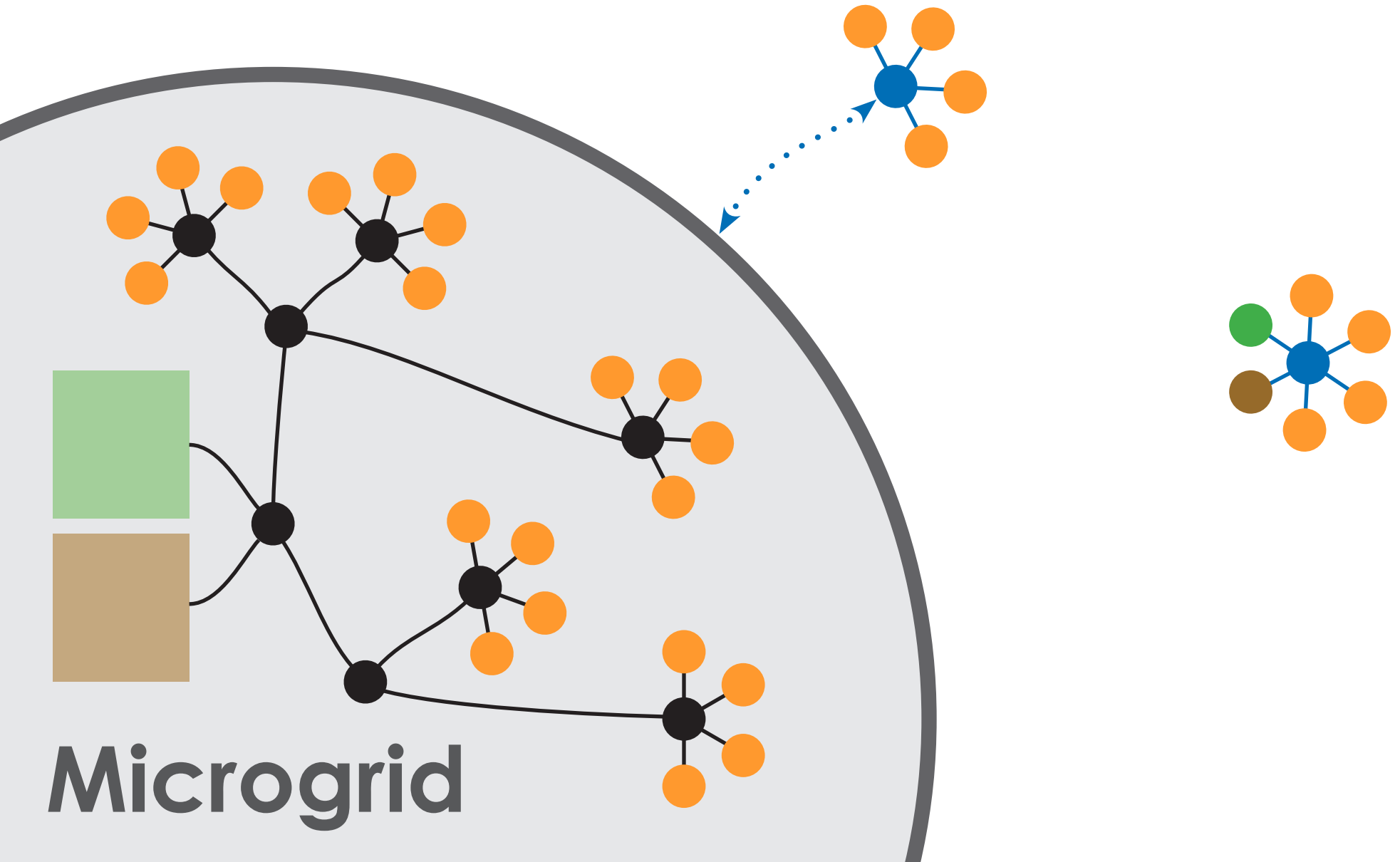

## 2. Inside the Microgrid

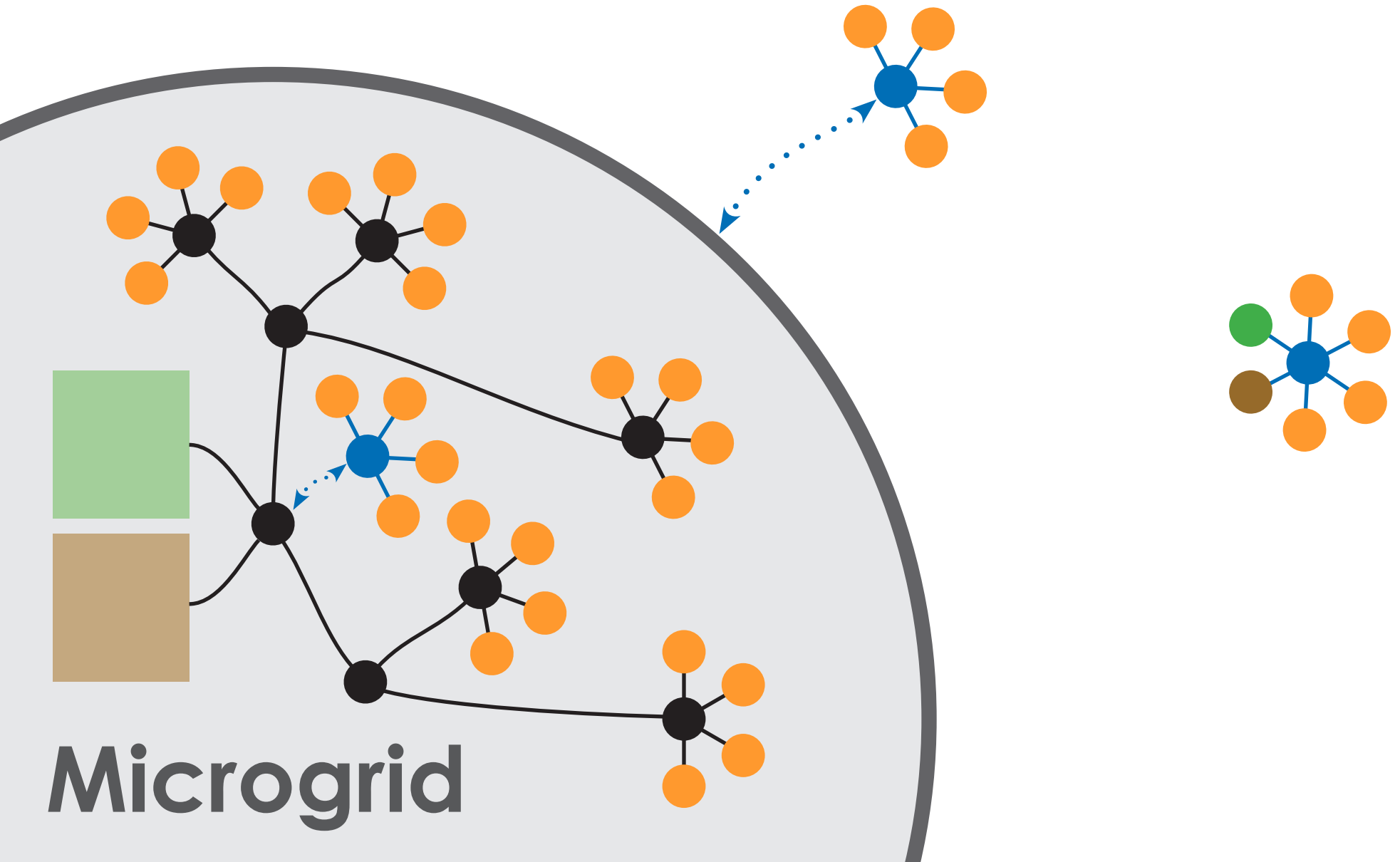

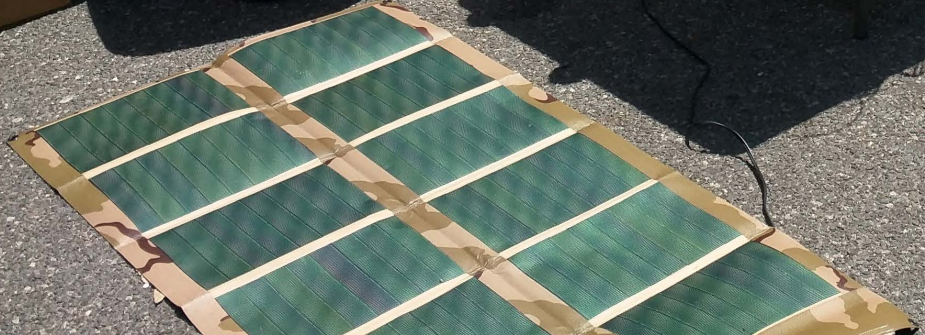



WHISPERWATT

CR50129

MQ POWER



WARNING: NEVER  
110V 50 HERTZ

## 2. Inside the Microgrid

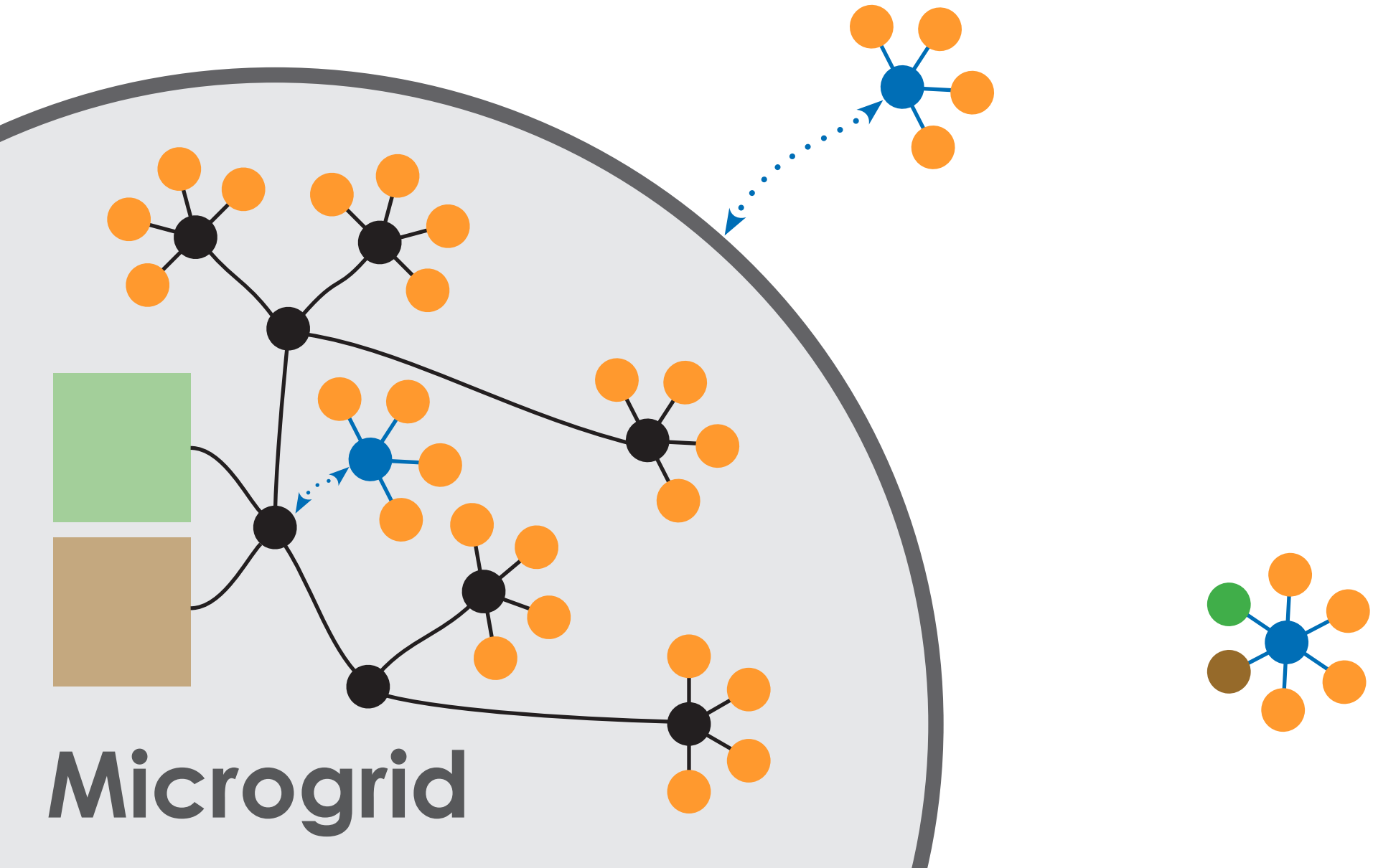



# 3. With the Microgrid

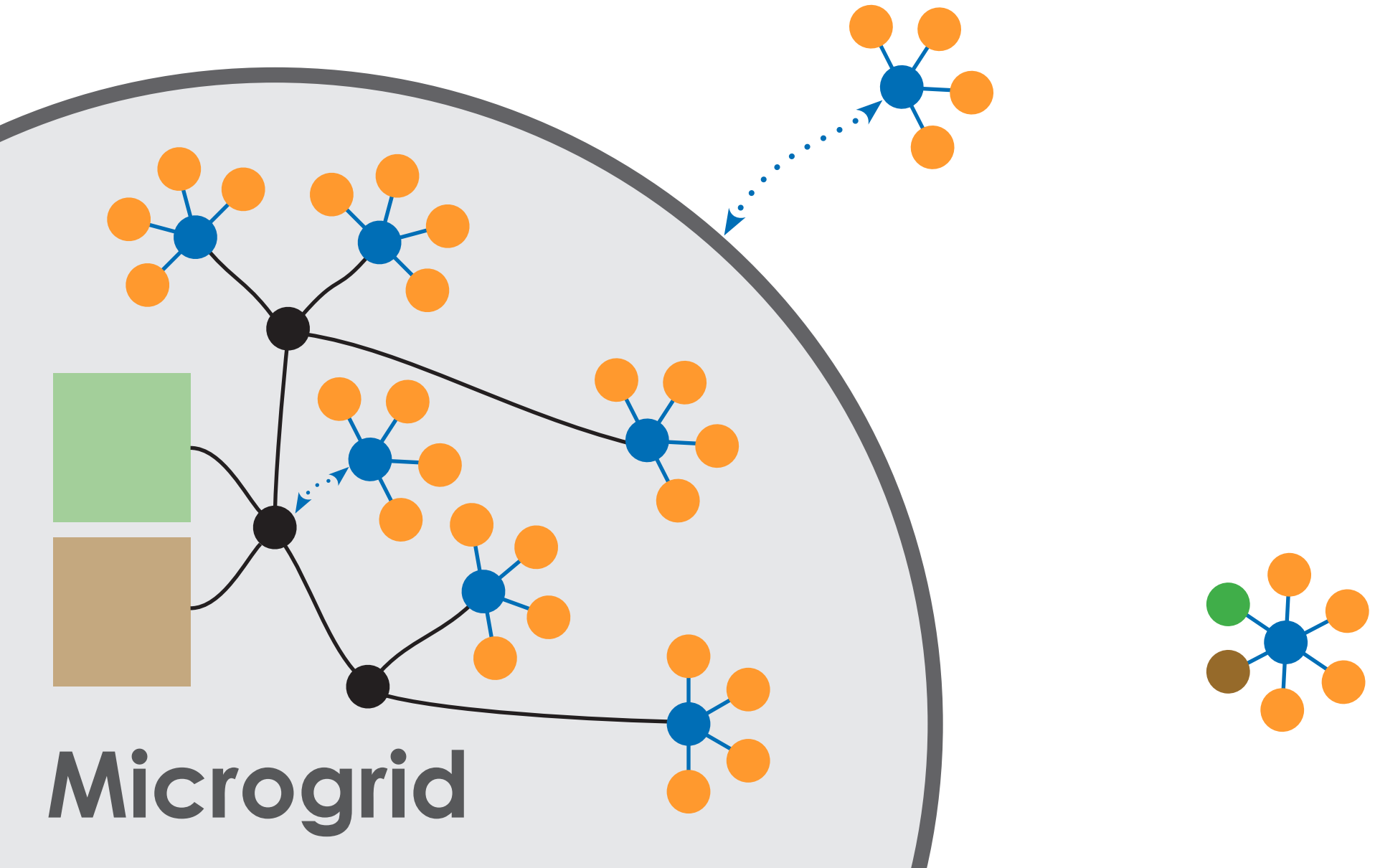

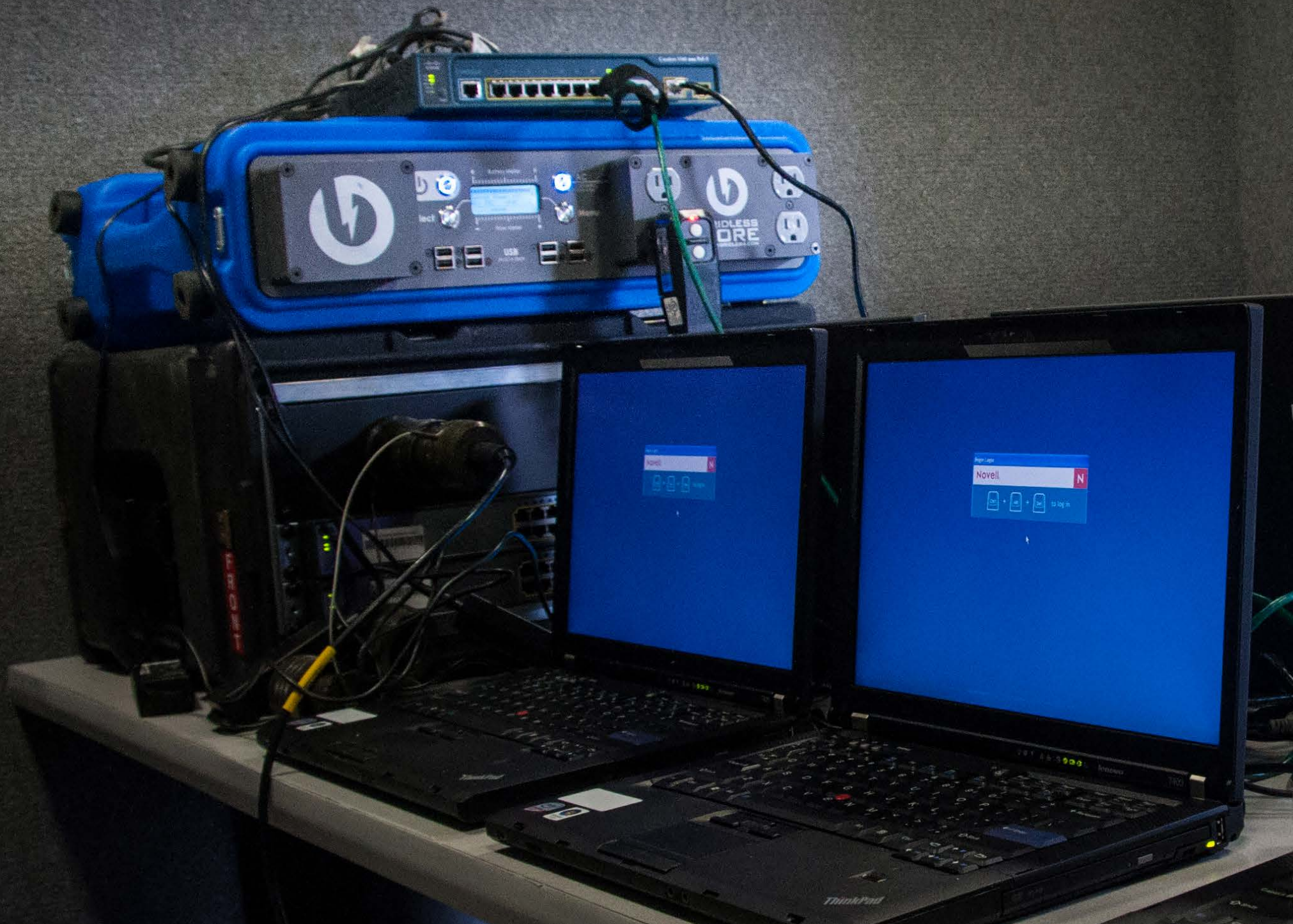

# 3. With the Microgrid

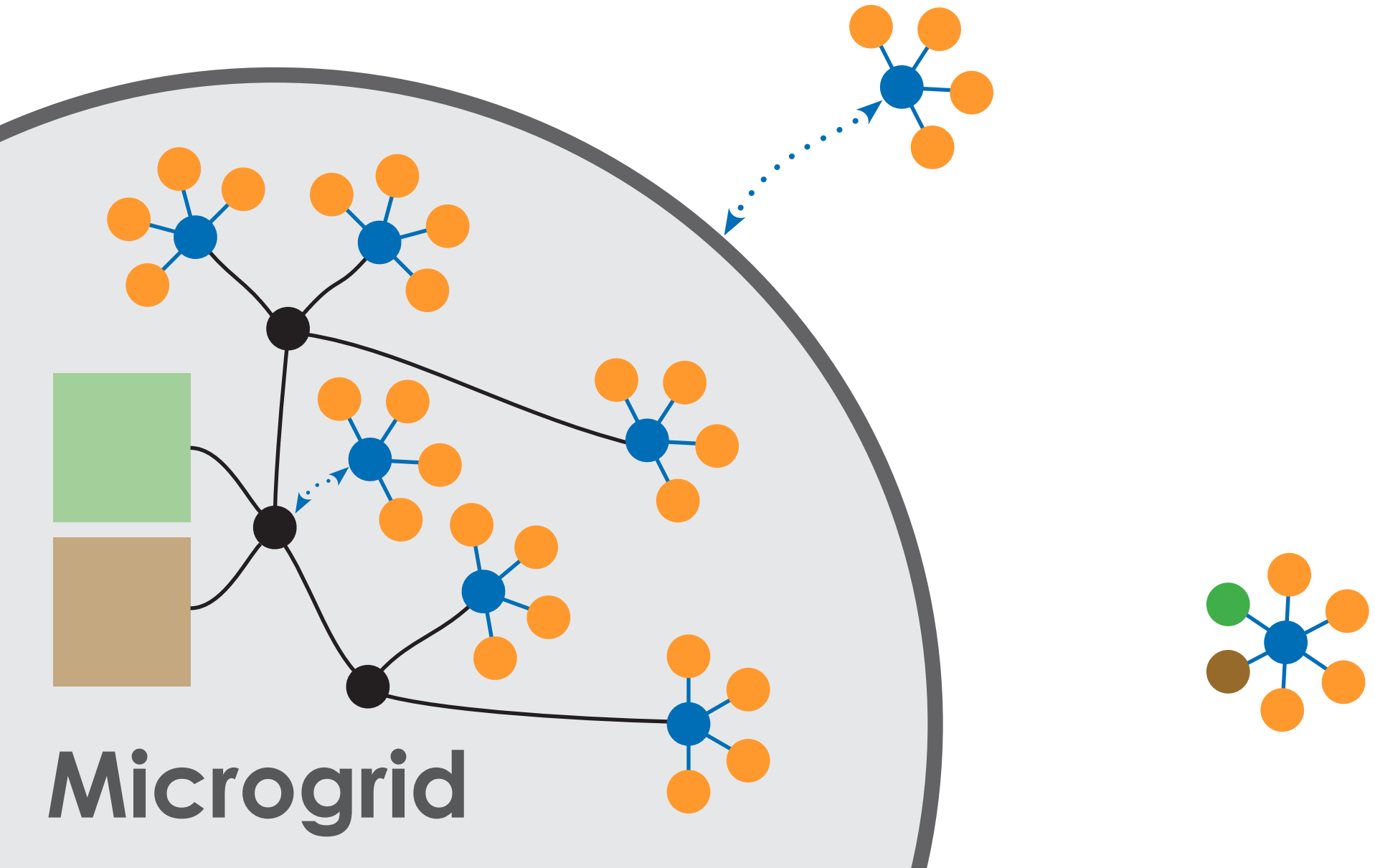

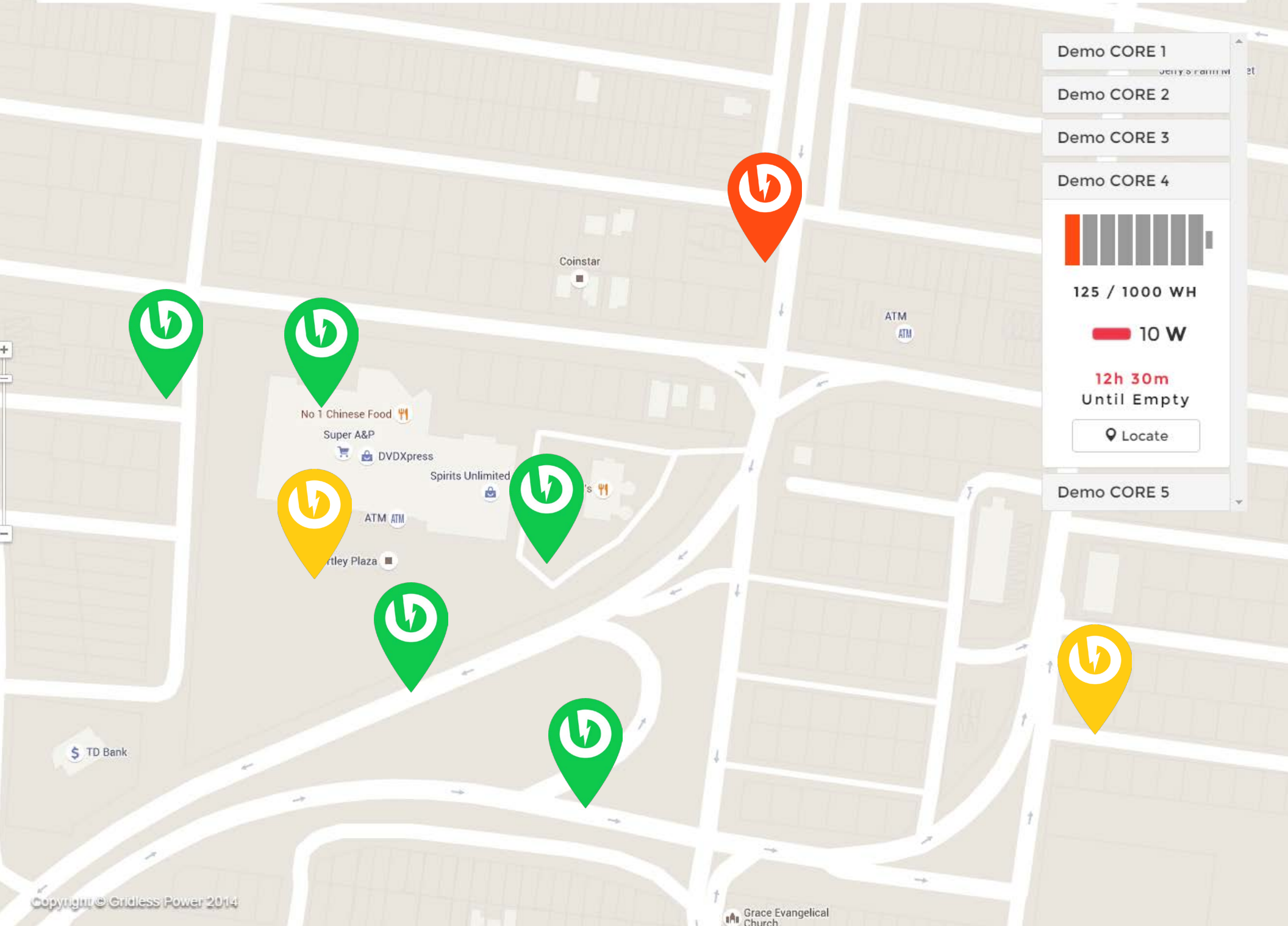

Demo CORE 1

Demo CORE 2

Demo CORE 3

Demo CORE 4



125 / 1000 WH

 10 W

12h 30m  
Until Empty

Demo CORE 5

# The Gridless Solution

Hardware + Software

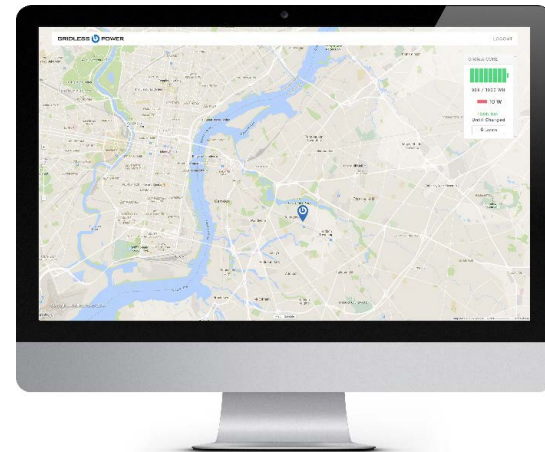



# GRIDLESS POWER

Jason Halpern  
Halpern@Gridless.com  
609-534-5386

