



SPECIAL OPERATIONS FORCES INDUSTRY CONFERENCE

LTC Shane Morris
Systems Acquisition Manager

MOBILITY

ROTARY WING

Agenda

- Portfolio's
- Mobility Roadmap
- MH-47G
- MH-60M
- Mission Enhanced Little Bird (MELB)
- Way Forward...

PEO Rotary Wing (RW) Portfolios

MOBILITY



A/MH-6 Light Attack/Assault



Medium Assault MH-60



Heavy Assault MH-47

MISSION EQUIPMENT



Active Aircraft Survivability Equipment

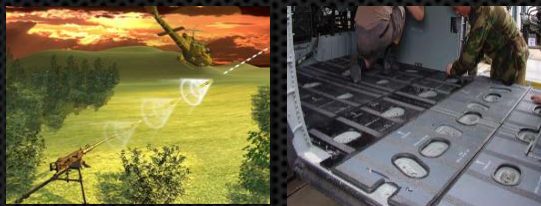

Passive Aircraft Survivability Equipment



Avionics



Sensors



Silent Knight Radar

TRAINING SYSTEMS



A/MH-6M Little Bird



MH-47G CMS



MH-60L/M CMS



Battle Staff Training Exercise Management Control

Mobility Roadmap

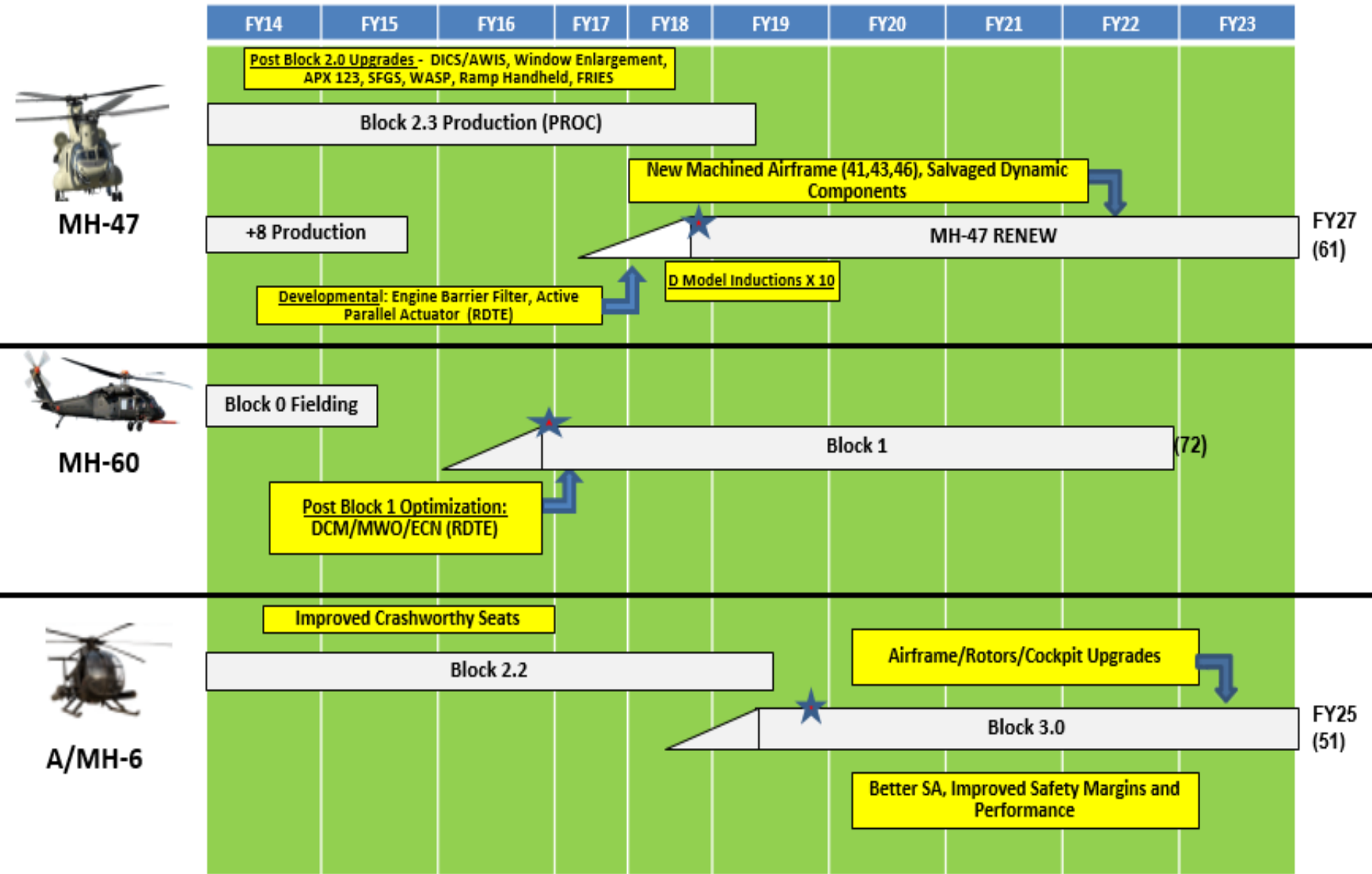

MH-47G Activities

- +8 New Build completion
- Block 2.3 execution
- RENEW
- Development Efforts
 - Advanced Parallel Actuator System (APAS)
 - Engine Barrier Filter

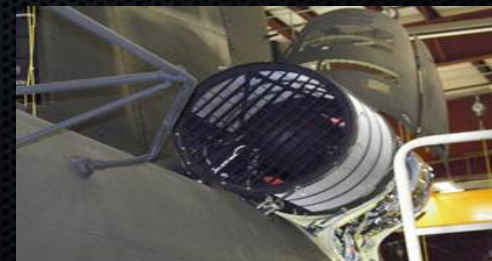
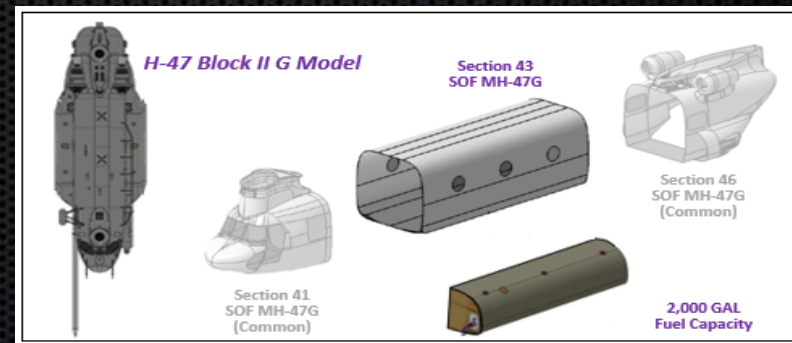

MH-60 Activities

- MH-60M Block 0 completion
- Block 1 Upgrade

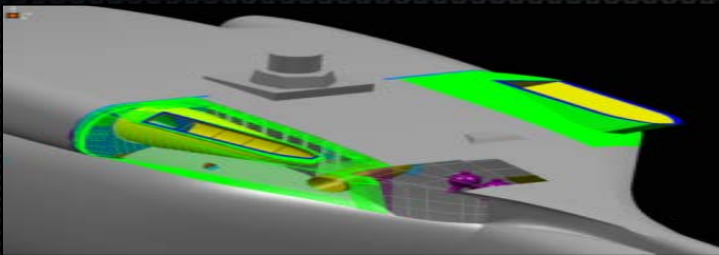

A/MH-6 Activities

- Block 2.2 upgrade execution
 - Improves crew safety
- Block 3.0 upgrade
 - Improves payload
 - Improves flight controls
 - Improves cockpit

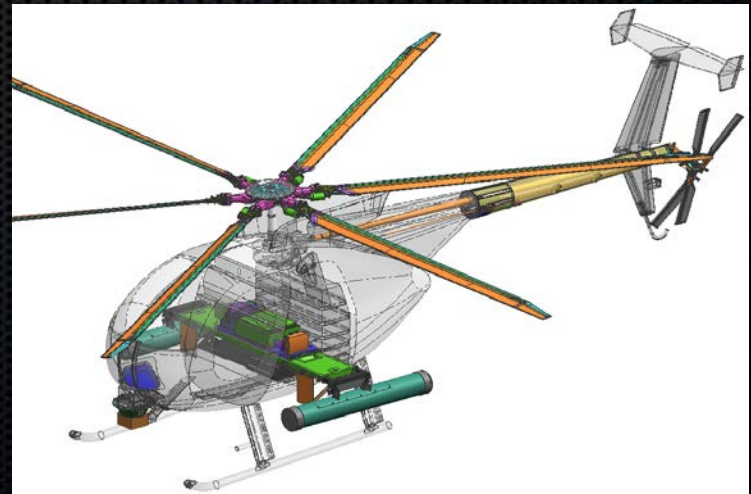

Way Forward...



Five Variants:

- 1) CS1- Light attack/assault (USA, SOCOM)
- 2) CS2- 60 replacement (USN, USCG)
- 3) CS3- H60/H64 replacement (USA, USMC, SOCOM)
- 4) CS4- CV22 replacement (SOCOM, USAF, USMC)
- 5) CS5- H47/H53 replacement (USMC, USA, SOCOM)

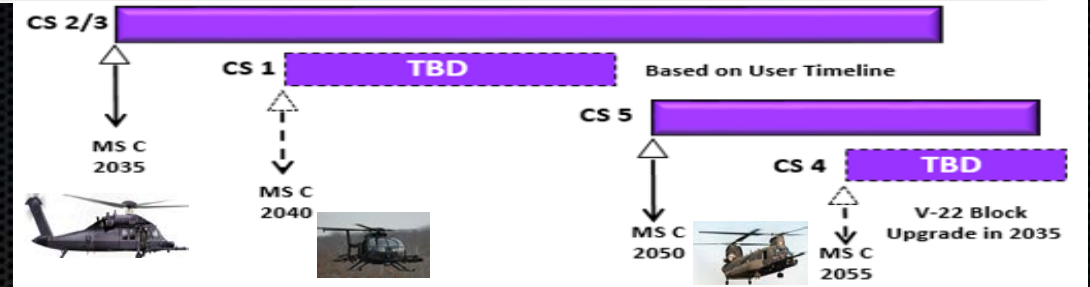

FVL "Light" (Capability Set 1)
MELB relevance thru 2040...



FVL "Medium" (Capability Set 2,3)
60M relevance thru 2040...



FVL "Heavy" (Capability Set 5)
47G relevance thru 2060...

SOF Requirements are Nested with Army FoS Capability Sets (CS)

Program Contacts

- LTC Mac Cornish - MH-47G PM
malcolm.s.cornish.mil@mail.mil
- LTC Louis Karnes – MH-60M PM
louis.j.karnes.mil@mail.mil
- Mr. Keith Hoff – A/MH-6 PM
keith.j.hoff.civ@mail.mil
- LTC Shane Morris (System Acq. Manager)
shane.morris3@socom.mil



Questions

